









PRODUCT CATALOGUE



Summary

-  **Catalogue 1**
Floodlights & High Bays
-  **Catalogue 2**
Ceiling LED Tiles
-  **Catalogue 3**
Flexible LED Strips
-  **Catalogue 4**
Controllers
-  **Catalogue 5**
Power Supplies
-  **Catalogue 6**
Aluminum Profiles
-  **Catalogue 7**
Decoration

Index

Floodlights & High Bays

1

Classic Floodlights

10W LED Floodlight 70°	page 1.5
10W LED Floodlight 120°	page 1.6
10W LED Floodlight 120° For Signage	page 1.7
30W LED Floodlight 90°	page 1.8
30W LED Floodlight 120°	page 1.9
50W LED Floodlight 90°	page 1.10
50W LED Floodlight 120°	page 1.11
70W LED Floodlight 40°	page 1.12
70W LED Floodlight 120°	page 1.13
200W LED Floodlight 40°	page 1.14
200W LED Floodlight 120°	page 1.15
Spotted Heavy Duty Series	page 1.16

Compact Floodlights

10W FLAT Floodlight 120°	page 1.18
30W FLAT Floodlight 120°	page 1.19
50W FLAT Floodlight 120°	page 1.20
100W FLAT Floodlight 120°	page 1.21
150W FLAT Floodlight 120°	page 1.22
Accessories For Floodlights	page 1.23

Floodlights For Special Applications

100W LED Floodlight	page 1.25
150 - 200W LED Floodlight	page 1.26
250W LED Floodlight	page 1.27
400W LED Floodlight	page 1.28
600W LED Floodlight	page 1.29
800W LED Floodlight	page 1.30
1000W LED Floodlight	page 1.31
Photometric Distribution Of Special Floodlight	page 1.32

Index

Low & High Bays

Low Bay LED Canopy Light	page 1.34
High Bay LED Lights 100W - 150W	page 1.35
High Bay LED Lights 200W - 250W	page 1.36
High Bay LED Lights 300W - 350W - 400W	page 1.37
Accessories For High Bay Lights	page 1.38

Ceiling LED Tiles

Ceiling LED Tile Details	page 2.3
30 x 30 900lm Ceiling LED Tile	page 2.4
60 x 60 3600lm Ceiling LED Tile	page 2.5
120 x 30 3600lm Ceiling LED Tile	page 2.6

Flexible LED Strips

Non Waterproof Flexible LED Strips

Non Waterproof Flexible LED Strip 60 LED 3528/m 22W	page 3.4
Non Waterproof Flexible LED Strip 120 LED 3528/m 45W	page 3.5
Non Waterproof Flexible LED Strip 72 LED 3014/m 44W	page 3.6
Non Waterproof Flexible LED Strip 120 led 3014/m 72W	page 3.7
Non Waterproof Flexible LED Strip 180 LED 3014/m 108W	page 3.8
Non Waterproof Flexible LED Strip 84 LED 5630/m 133W	page 3.9
Non Waterproof Flexible LED Strip 30 LED 5050/m (RGB) 36W	page 3.10
Non Waterproof Flexible LED Strip 60 LED 5050/m (RGB) 72W	page 3.11
Non Waterproof Flexible LED Strip 60 LED 5050/m 72W	page 3.12

LED strip connectors

Solderless Connectors	page 3.14
-----------------------	-----------

1

2

3

Index

Controllers

Spotted Light Control KIT	
Color Wheel LED Remote Control & Receiver	page 4.4
Spotted Light Control Remote Control	page 4.5
Spotted Light Control Constant Voltage Receiver	
Spotted Light Control Constant Current Receiver	page 4.6
Spotted Light Control Constant Voltage Receiver with buttons	page 4.7
Spotted Light Control D Series Touch Panel Controller	page 4.8
Spotted Light Control Power Amplifier	page 4.9
Sunlite DMX Controller Stick 2	page 4.10
Sunlite DMX Controller DE3	page 4.11
Spotted Light Control DMX 512 Interface	page 4.12
Arditi Push Button RGB Controller	page 4.13
Arditi Dimmable LED Power Supplies	page 4.14

Power supplies

Constant Voltage

Low Power Lighting PSU	page 5.4
Waterproof Low Power PSU	page 5.5
Waterproof Low Power PSU (CV + CC)	page 5.6
Waterproof High Power PSU	page 5.7
Waterproof Mains Dimmable LED Power Supplies 12V, 24V	page 5.8
Waterproof High Power PSU (CV + CC)	page 5.9
Din Rail Power Supplies 30 > 100 W	
Din Rail Power Supplies 120 > 960 W	page 5.10

Constant Current

Low Power Lighting PSU	page 5.12
------------------------	-----------

4

5

Index

Aluminum Profiles

Aluminum LED Profile 1504 (2m)	6	page 6.4
Aluminum LED Profile 1911 (2m)		page 6.5
Aluminum LED Profile 1808 (2m)		page 6.6
Aluminum Recessed LED Profile 2508 (2m)		page 6.7
Aluminum LED Profile 1812 (2m)		page 6.8
Aluminum Recessed LED Profile 2515 (2m)		page 6.9
Aluminum Wide LED Profile 2208 (2m)		page 6.10
Aluminum Wide LED Profile 2215 (2m)		page 6.11
Aluminum LED Profile 3535 (2m)		page 6.12
Aluminum Recessed LED Profile 4435 (2m)		page 6.13
Aluminum Round LED Profile RD25 (2m)		page 6.14
Aluminum Stair Step Nose LED Profile SR66 (2m)		page 6.15
Aluminum Wall Recessed LED Profile WL70 (2m)		page 6.16
Aluminum Corner LED Profile XL45 (2m)		page 6.17
Aluminum Recessed LED Profile 3315 (2m)		page 6.18
Aluminum Adjustable LED Profile AD20 (2m)		page 6.19
Aluminum H-Shape LED Profile 3018 (2m)		page 6.20

Decoration

Mini Ground Spot 40mm	7	page 7.3
High Power Ground Spot		page 7.4
Cubic LED Wall Downlight		page 7.5
Halo LED Light		page 7.6



Floodlights & High Bays



Notes

Classic Floodlights

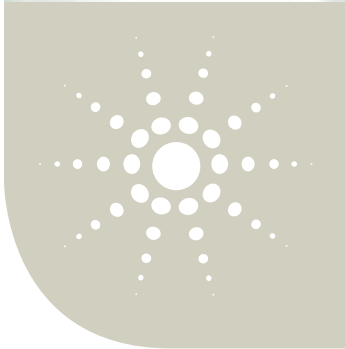
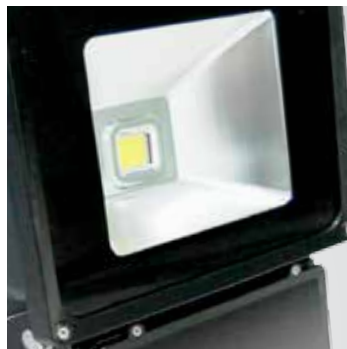

10W LED FLOODLIGHT 70°

Property	Value
LED Power	10W
System Power	10.5W
Input Voltage	230V
LED	Spotled Bridgelux
Light Output	860lm
CCT	3200K / 4500K [other CCT/colors on request]
Life Span	50000h
CRI	>80
PF	> 0.75
IP Level	IP65
Beam Angle	70°
Casing Color	Black / Grey
Dimmable	No
Dimensions	85x115x87mm
Cable Length	0.8m
Weight	0.6kg
Certificates	CE, ROHS
Warranty	2 years

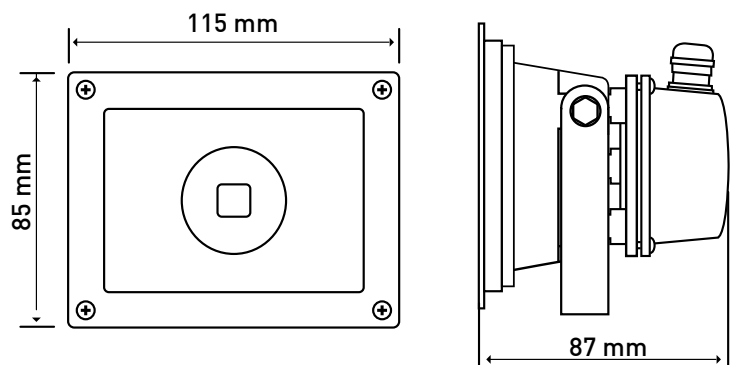

Goniogram

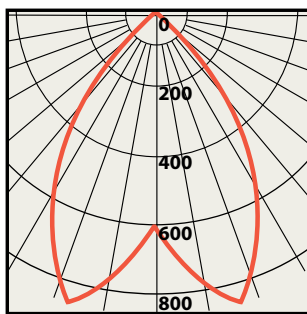

Goniogram for a 70° Fixture

High reliability
LED chips by



References:

Model	Description	GTIN / EAN	Price*
BB010PSH907030	3200K 70° Black	5420061210296	€ 49.00
BB010PSH907045	4500K 70° Black	5420061212351	€ 49.00
BB010PSHG07030	3200K 70° Grey	5420061212467	€ 49.00
BB010PSHG07045	4500K 70° Grey	5420061212474	€ 49.00

*BRUTO WITHOUT VAT/PIECE

10W LED FLOODLIGHT 120°

Property	Value
LED Power	10W
System Power	10.5W
Input Voltage	230V Or 12 / 30VDC PWM Dimmable
LED	Spotled Bridgelux
Light Output	860lm
CCT	3200K / 4500K (other CCT/colors on request)
Life Span	50000h
CRI	> 80
PF	> 0.75
IP Level	IP65
Beam Angle	120°
Casing Color	Black / Grey (other colors on request)
Dimmable	No
Dimensions	85x115x87mm
Cable Length	0.8m
Weight	0.6kg
Certificates	CE, ROHS
Warranty	2 years

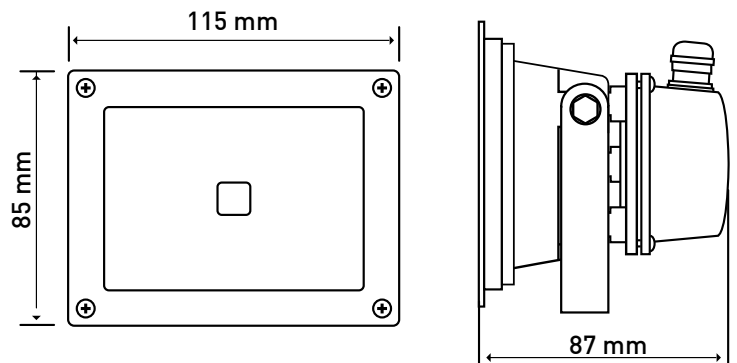

Goniogram

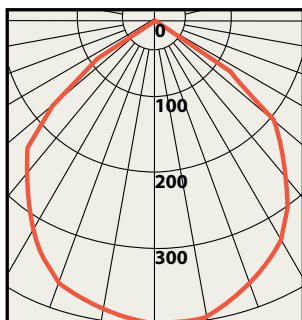

Goniogram for a 120° Fixture

High reliability
LED chips by



References:

Model	Description	GTIN / EAN	Price*
BB010PSH912030	230V 3200K 120° Black	5420061204172	€ 44.00
BB010PSH912045	230V 4500K 120° Black	5420061204158	€ 44.00
BB010PSHG12030	230V 3200K 120° Grey	5420061210081	€ 44.00
BB010PSHG12045	230V 4500K 120° Grey	5420061209931	€ 44.00
BB010PDNB12032	12-30V Dim 3200K 120° Black	5420061218582	€ 49.00
BB010PDNB12045	12-30V Dim 4500K 120° Black	5420061218599	€ 49.00

Signage

10W LED FLOODLIGHT 120°

Property	Value
LED Power	10W
System power	10.5W
Input Voltage	230V
LED	Spotled Bridgelux
Light Output	860lm
CCT	4500K
Life Span	50000h
CRI	> 80
PF	> 0.75
IP Level	IP65
Beam Angle	120°
Casing Color	Black / Grey / White
Dimmable	No
Dimensions	85x115x87mm
Cable Length	1.5m
Weight	0.6kg
Certificates	CE, ROHS
Warranty	2 years



Inverted cable gland position
for downwards lighting

High reliability
LED chips by



References:

Model	Description	GTIN / EAN	Price*
BBS10PSHB12045	4500K 120° Black	5420061215864	€ 49.00
BBS10PSHW12045	4500K 120° White	5420061215871	€ 49.00
BBS10PSHG12045	4500K 120° Grey	5420061214782	€ 49.00

*BRUTO WITHOUT VAT/PIECE

STAINLESS STEEL ARM

Property

Stainless Steel Arm
750x20mm with
M10 hole and 30x30x100
mounting brackets



Reference:

Model	GTIN / EAN	PRICES*
ZINOXBRA020750	5420061216540	€ 79.90

*BRUTO WITHOUT VAT/PIECE

30W LED FLOODLIGHT 90°

Property	Value
LED Power	30W
System Power	31W
Input Voltage	230V
LED	Spotled Bridgelux
Light Output	2600lm
CCT	3200K / 4500K (other CCT/colors on request)
Life Span	50000h
CRI	> 80
PF	> 0.96
IP Level	IP65
Beam Angle	90°
Casing Color	Black / Grey
Dimmable	No
Dimensions	185x225x130mm
Cable Length	0.8m
Weight	2.4kg
Certificates	CE, ROHS
Warranty	2 years

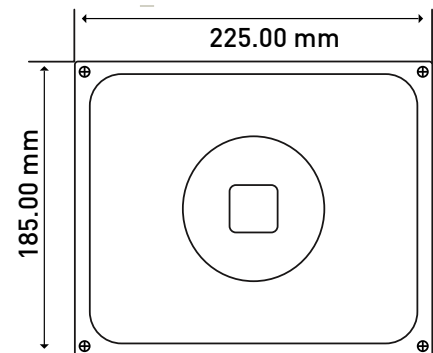
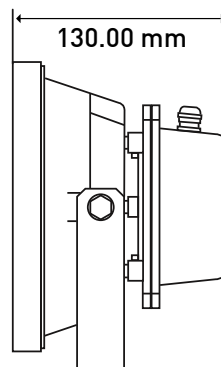

Goniogram

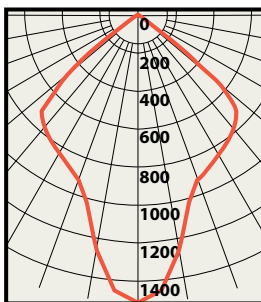

Goniogram for a 90° Fixture

High reliability
LED chips by



References:

Model	Description	GTIN / EAN	Price*
BB030PSH909030	3200K 90° Black	5420061207401	€ 124.00
BB030PSH909045	4500K 90° Black	5420061207395	€ 124.00
BB030PSHG09030	3200K 90° Grey	5420061212504	€ 124.00
BB030PSHG09045	4500K 90° Grey	5420061212511	€ 124.00

Heavy duty version on request

*BRUTO WITHOUT VAT/PIECE

30W LED FLOODLIGHT 120°

Property	Value
LED Power	30W
System Power	31W
Input Voltage	230V
LED	Spotled Bridgelux
Light Output	2600lm
CCT	3200K / 4500K (other CCT/colors on request)
Life Span	50000h
CRI	> 80
PF	> 0.96
IP Level	IP65
Beam Angle	120°
Casing Color	Black / Grey (other colors on request)
Dimmable	No
Dimensions	185x225x130mm
Cable Length	0.8m
Weight	2.4kg
Certificates	CE, ROHS
Warranty	2 years

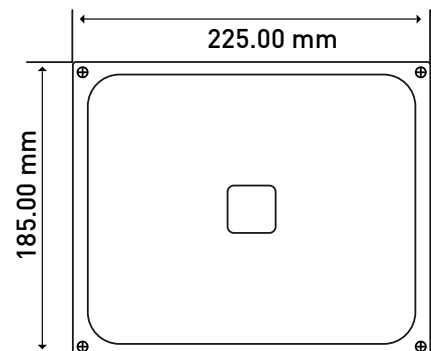
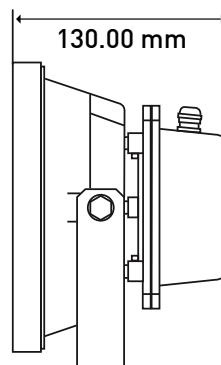

Goniogram

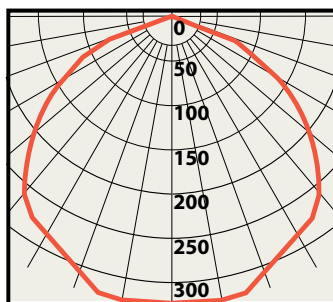

Goniogram for a 120° Fixture

High reliability
LED chips by



References:

Model	Description	GTIN / EAN	Price*
BB030PSH912030	3200K 120° Black	5420061207333	€ 124.00
BB030PSH912045	4500K 120° Black	5420061207388	€ 124.00
BB030PSHG12030	3200K 120° Grey	5420061210555	€ 124.00
BB030PSHG12045	4500K 120° Grey	5420061210074	€ 124.00

Heavy duty version on request

*BRUTO WITHOUT VAT/PIECE

50W LED FLOODLIGHT 90°

Property	Value
LED Power	50W
System Power	52W
Input Voltage	230V
LED	Spotled Bridgelux
Light Output	4300lm
CCT	3200K / 4500K (other CCT/colors on request)
Life Span	50000h
CRI	> 80
PF	> 0.96
IP Level	IP65
Beam Angle	90°
Casing Color	Black / Grey
Dimmable	No
Dimensions	236x287x155mm
Cable Length	0.8m
Weight	3.6kg
Certificates	CE, ROHS
Warranty	2 years

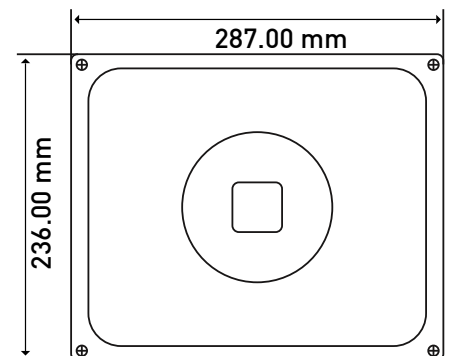
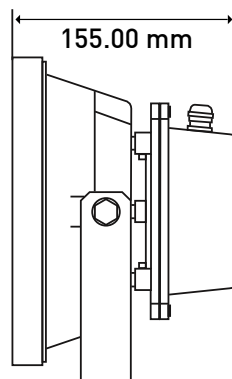

Goniogram

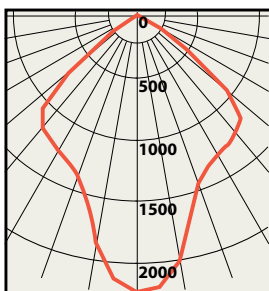

Goniogram for a 90° Fixture

High reliability
LED chips by



References:

Model	Description	GTIN / EAN	Price*
BB050PSH909030	3200K 90° Black	5420061200921	€ 184.00
BB050PSH909045	4500K 90° Black	5420061200884	€ 184.00
BB050PSHG09030	3200K 90° Grey	5420061212566	€ 184.00
BB050PSHG09045	4500K 90° Grey	5420061212573	€ 184.00

Heavy duty version on request

*BRUTO WITHOUT VAT/PIECE

50W LED FLOODLIGHT 120°

Property	Value
LED Power	50W
System Power	52W
Input Voltage	230V
LED	Spotled Bridgelux
Light Output	4300lm
CCT	3200K / 4500K (other CCT/colors on request)
Life Span	50000h
CRI	> 80
PF	> 0.96
IP Level	IP65
Beam Angle	120°
Casing Color	Black / Grey
Dimmable	No
Dimensions	236x287x155mm
Cable Length	0.8m
Weight	3.6kg
Certificates	CE, ROHS
Warranty	2 years

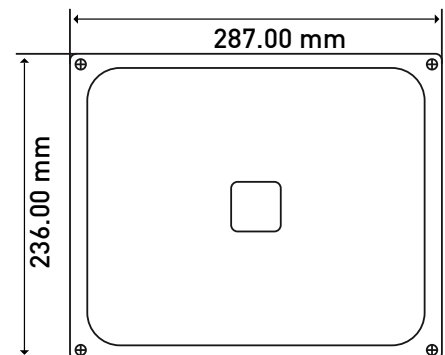
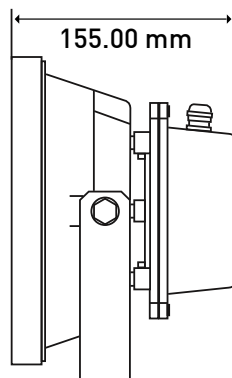

Goniogram

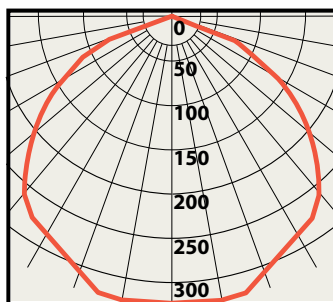

Goniogram for a 120° Fixture

High reliability
LED chips by



References:

Model	Description	GTIN / EAN	Price*
BB050PSH912030	3200K 120° Black	5420061200877	€ 184.00
BB050PSH912045	4500K 120° Black	5420061200860	€ 184.00
BB050PSHG12030	3200K 120° Grey	5420061212535	€ 184.00
BB050PSHG12045	4500K 120° Grey	5420061212542	€ 184.00

Heavy duty version on request

*BRUTO WITHOUT VAT/PIECE

70W LED FLOODLIGHT 40°

Property	Value
LED Power	70W
System Power	74W
Input Voltage	230V
LED	Spotled Bridgelux
Light Output	5800lm
CCT	3200K / 4500K [other CCT/colors on request]
Life Span	50000h
CRI	> 80
PF	> 0.96
IP Level	IP65
Beam Angle	40°
Casing Color	Black / Grey
Dimmable	No
Dimensions	374x290x120mm
Cable Length	0.8m
Weight	6.2kg
Certificates	CE, ROHS
Warranty	2 years

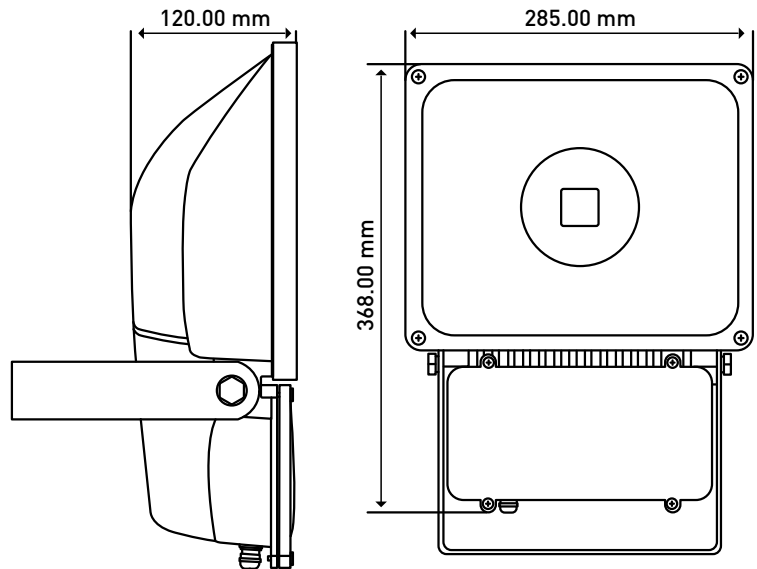

Goniogram

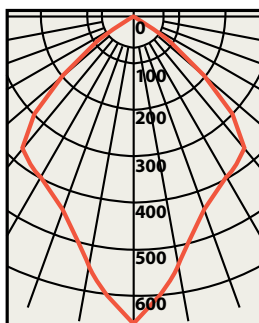

Goniogram for a 40° Fixture

High reliability
LED chips by



References:

Model	Description	GTIN / EAN	Price*
BB070PSH904030	3200K 40° Black	5420061202871	€ 289.00
BB070PSH904045	4500K 40° Black	5420061202864	€ 289.00
BB070PSHG04030	3200K 40° Grey	5420061212627	€ 289.00
BB070PSHG04045	4500K 40° Grey	5420061212634	€ 289.00

*BRUTO WITHOUT VAT/PIECE

Heavy duty version on request

70W LED FLOODLIGHT 120°

Property	Value
LED Power	70W
System Power	74W
Input Voltage	230V
LED	Spotled Bridgelux
Light Output	5800lm
CCT	3200K / 4500K (other CCT/colors on request)
Life Span	50000h
CRI	> 80
PF	> 0.96
IP Level	IP65
Beam Angle	120°
Casing Color	Black / Grey
Dimmable	No
Dimensions	374x290x120mm
Cable Length	0.8m
Weight	6.2kg
Certificates	CE, ROHS
Warranty	2 years

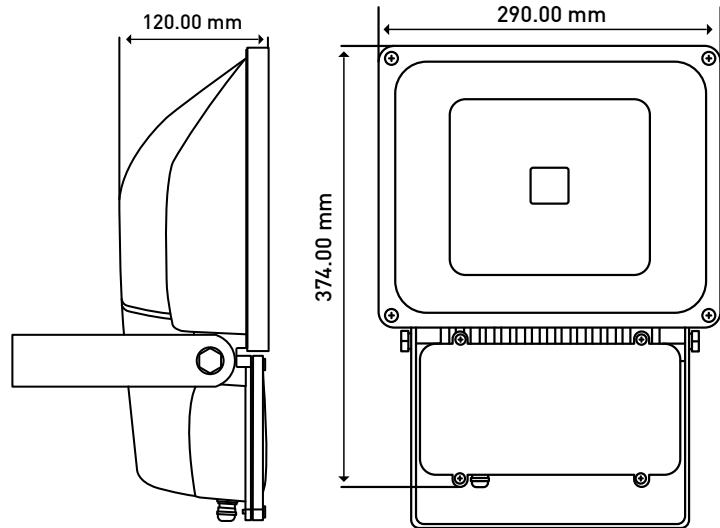

Goniogram

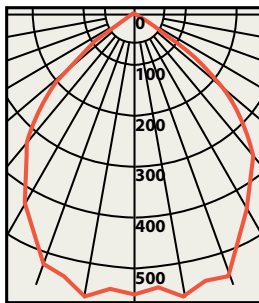

Goniogram for a 120° Fixture

High reliability
 LED chips by



References:

Model	Description	GTIN / EAN	Price*
BB070PSH912030	3200K 120° Black	5420061202420	€ 289.00
BB070PSH912045	4500K 120° Black	5420061202444	€ 289.00
BB070PSHG12030	3200K 120° Grey	5420061212597	€ 289.00
BB070PSHG12045	4500K 120° Grey	5420061212603	€ 289.00

*BRUTO WITHOUT VAT/PIECE

Heavy duty version on request

200W LED FLOODLIGHT 40°

Property	Value
LED Power	200W
System Power	205W
Input Voltage	230V
LED	Spotled Super Bridgelux
Light Output	19000lm*
CCT	3200K / 4500K (other CCT/colors on request)
Life Span	50000h
CRI	> 80
PF	> 0.96
IP Level	IP65
Beam Angle	40°
Casing Color	Black
Dimmable	No
Dimensions	397x552x172mm
Cable Length	2m
Weight	16.5kg
Certificates	CE, ROHS
Warranty	3 years

* from batch B1436

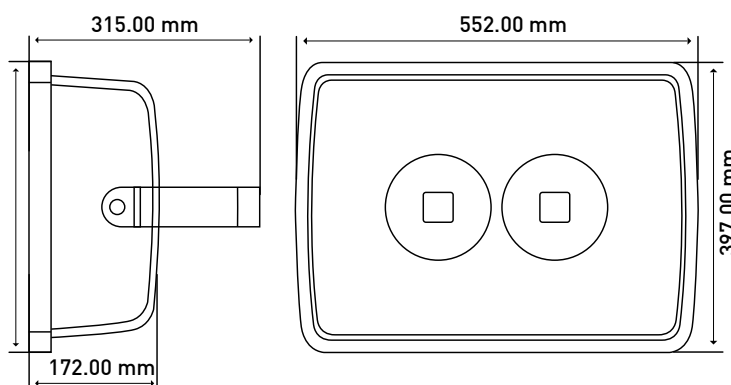

Goniogram

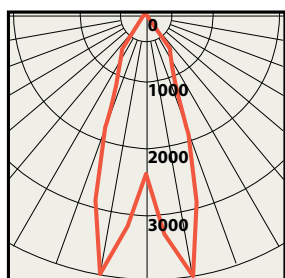

Goniogram for a 40° Fixture

High reliability
LED chips by



References:

Model	Description	GTIN / EAN	Price*
BB200PSH904030	3200K 40° Black	5420061212405	€ 1099.00
BB200PSH904045	4500K 40° Black	5420061212412	€ 1099.00

*BRUTO WITHOUT VAT/PIECE

200W LED FLOODLIGHT 120°

Property	Value
LED Power	200W
System Power	205W
Input Voltage	230V
LED	Spotled Super Bridgelux
Light Output	20000lm*
CCT/Color	3200K / 4500K (other CCT/colors on request)
Life Span	50000h
CRI	> 80
PF	> 0.96
IP Level	IP65
Beam Angle	120°
Casing Color	Black (other colors on request)
Dimmable	No
Dimensions	397x552mmx172
Cable Length	2m
Weight	16.5kg
Certificates	CE, ROHS
Warranty	3 years

* from batch B1436

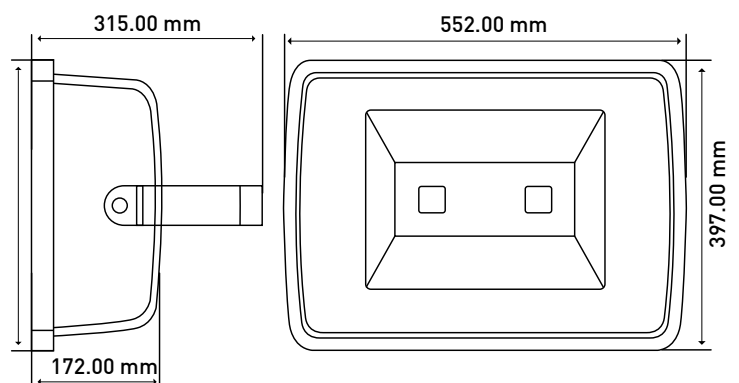

Goniogram

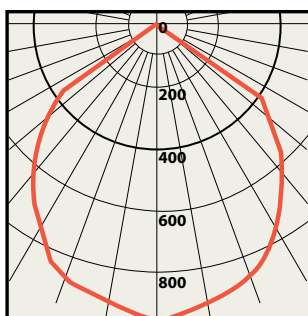

Goniogram for a 120° Fixture

High reliability
LED chips by



References:

Model	Description	GTIN / EAN	Price*
BB200PSH912030	3200K 120° Black	5420061212375	€ 1099.00
BB200PSH912045	4500K 120° Black	5420061212382	€ 1099.00

*BRUTO WITHOUT VAT/PIECE

SPOTLED HEAVY DUTY SERIES

Standard versions of LED floodlights are not designed to support regular voltage fluctuations near gas-discharge lamps, motors or inverters. Therefore, it is not suitable for industrial use.



For this purpose, we recommend using the improved **Spotled Heavy Duty Series**.

Properties of HEAVY floodlights

- Super Bridgelux LED for 100 lm / W Floodlights
- LEDs strictly sorted in our laboratory according to their bin, color temperature and flux
- Premium Brand Drivers with wide voltage input
- Adaptation of fixations on LEDs and drivers
- Polycarbonate front cover for food safe solutions

These products are assembled in our workshops in Seraing (Belgium). They are designed to be used in hard conditions and harsh environments. High power floodlights (from 100W) are already designed according to Heavy Duty properties. For any specific application involving special requirements, please send us your request.

For low power, in industrial environment, we recommend:

References:

Model	Description	GTIN / EAN	Price*
BBH30PSH912045	LED Floodlight 30W 120° 4500K Black 3m cable Heavy Duty	5420061221919	€ 244.00
BBH50PSH912045	LED Floodlight 50W 120° 4500K Black 3m cable Heavy Duty	5420061218360	€ 270.00
BBH70PSH912045	LED Floodlight 70W 120° 4500K Black 3m cable Heavy Duty	5420061218384	€ 405.00

Food safe

Model	Description	GTIN / EAN	Price*
BBH30PSH912045FS	30W 120° 4500K Black 3m cable Heavy Duty Food Safe	5420061235855	€ 294.00
BBH50PSH912045FS	50W 120° 4500K Black 3m cable Heavy Duty Food Safe	5420061235862	€ 320.00
BBH70PSH912045FS	70W 120° 4500K Black 3m cable Heavy Duty Food Safe	5420061235879	€ 455.00

Compact Floodlights

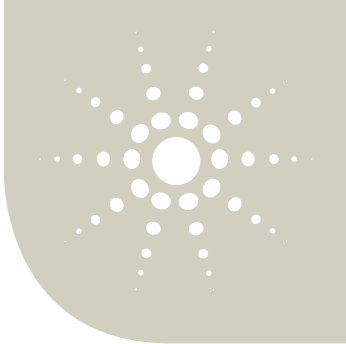
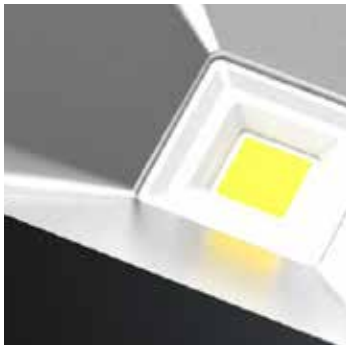

10W FLAT FLOODLIGHT 120°

Property	Value
LED Power	10W
System power	10.5W
Input Voltage	230V
LED	Spotled Epistar Spotled Super Bridgelux
Light Output	800lm /1000lm*
CCT	3200K / 4500K
Life Span	50000h
CRI	> 80
PF	> 0.75
IP Level	IP65
Beam Angle	120°
Casing Color	Black (other colors on request)
Dimmable	No
Dimensions	53x132x159mm
Cable Length	0.8m
Weight	0.6kg
Certificates	CE, ROHS
Warranty	3 years

* from batch B1436

Goniogram

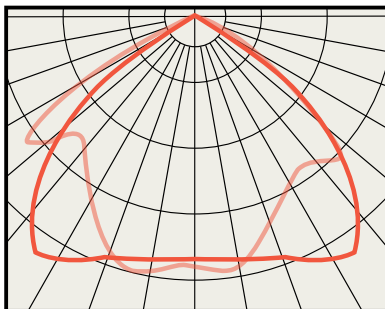

Goniogram for a 120° Fixture

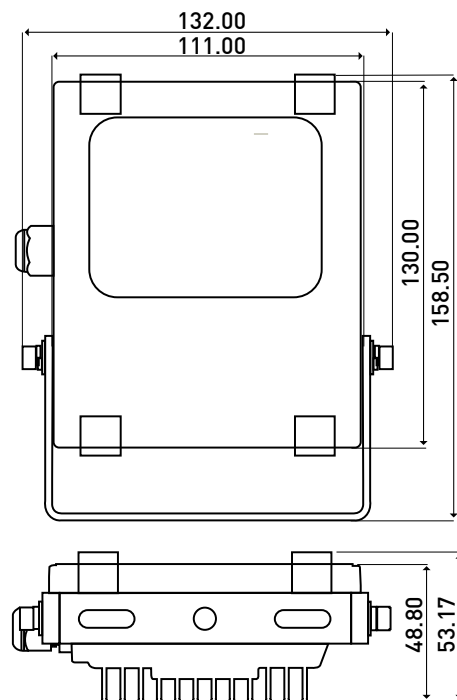

High reliability LED chips by



References:

Model	Description	GTIN / EAN	Price*
BP011PSH912032	3200K 120° Black Epistar	5420061232410	€ 39.00
BB011PSH912045	4500K 120° Black Bridgelux	5420061232441	€ 49.00

*BRUTO WITHOUT VAT/PIECE

30W FLAT FLOODLIGHT 120°

Property	Value
LED Power	30W
System Power	31W
Input Voltage	230V
LED	Spotled Epistar Spotled Super Bridgelux
Light Output	2400lm / 3000lm*
CCT	3200K / 4500K
Life Span	50000h
CRI	> 80
PF	> 0.96
IP Level	IP65
Beam Angle	120°
Casing Color	Black (other colors on request)
Dimmable	No
Dimensions	64x191x219mm
Cable Length	0.8m
Weight	1.6kg
Certificates	CE, ROHS
Warranty	3 years

* from batch B1436

Goniogram

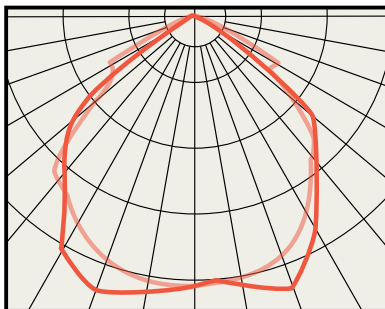

Goniogram for a 120° Fixture

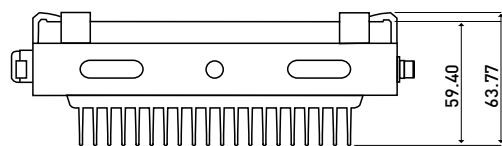
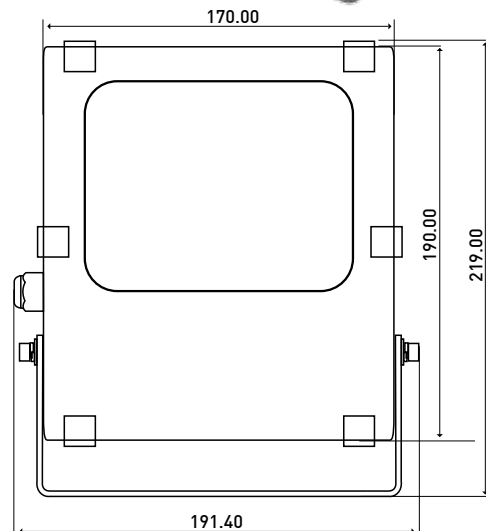
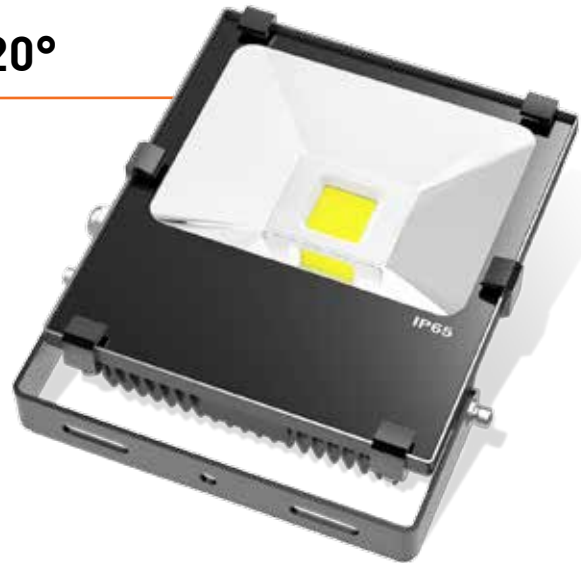

High reliability LED chips by



References:

Model	Description	GTIN / EAN	Price*
BP031PSH912032	3200K 120° Black Epistar	5420061232427	€ 89.00
BB031PSH912045	4500K 120° Black Bridgelux	5420061232458	€ 109.00

*BRUTO WITHOUT VAT/PIECE

50W FLAT FLOODLIGHT 120°

Property	Value
LED Power	50W
System Power	52W
Input Voltage	230V
LED	Spotled Epistar Spotled Super Bridgelux
Light Output	4000lm / 5000lm*
CCT	3200K / 4500K
Life Span	50000h
CRI	> 80
PF	> 0.96
IP Level	IP65
Beam Angle	120°
Casing Color	Black (other colors on request)
Dimmable	No
Dimensions	113x220x282mm
Cable Length	0.8m
Weight	2.6kg
Certificates	CE, ROHS
Warranty	3 years

* from batch B1436

Goniogram

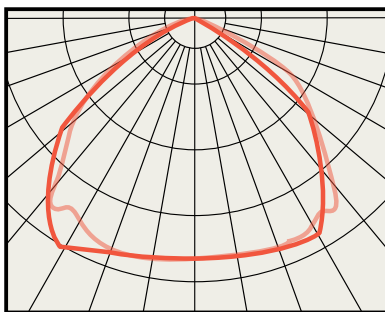

Goniogram for a 120° Fixture

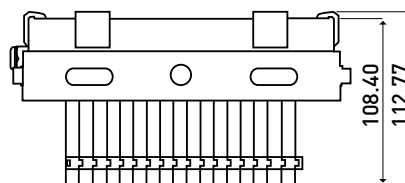
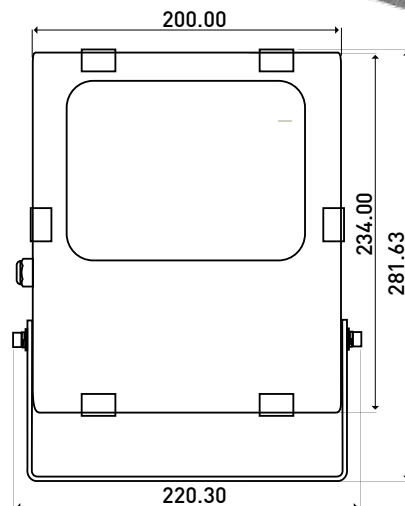

High reliability LED chips by



References:

Model	Description	GTIN / EAN	Price*
BP051PSH912032	3200K 120° Black Epistar	5420061232434	€ 179.00
BB051PSH912045	4500K 120° Black Bridgelux	5420061232465	€ 209.00

*BRUTO WITHOUT VAT/PIECE

100W FLAT FLOODLIGHT 120°

Property	Value
LED Power	100W
System Power	105W
Input Voltage	230V
LED	Spotled Epistar Spotled Super Bridgelux
Light Output	8000lm / 10000lm*
CCT	4500K
Life Span	50000h
CRI	> 80
PF	> 0.96
IP Level	IP65
Beam Angle	120°
Casing Color	Black (other colors on request)
Dimmable	No
Dimensions	182x268x310mm
Cable Length	1.5m
Weight	5.8kg
Certificates	CE, ROHS
Warranty	3 years

* from batch B1436

Goniogram

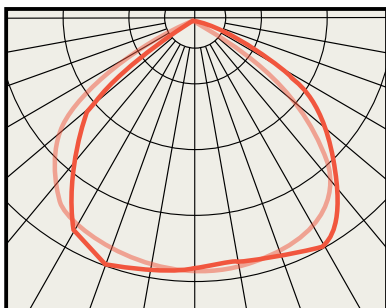

Goniogram for a 120° Fixture



Made
in
Belgium

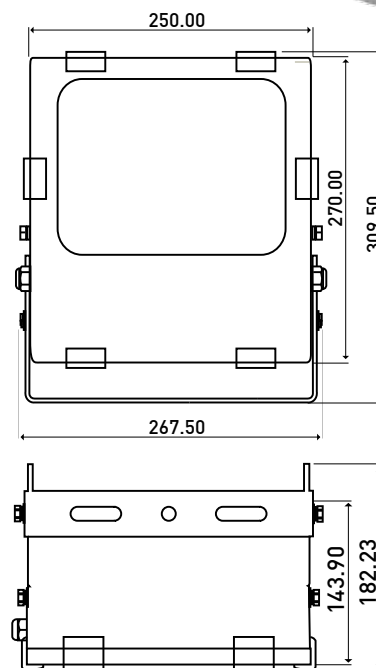

High reliability LED chips by



References:

Model	Description	GTIN / EAN	Price*
BP101PSH912045	4500K 120° Black Epistar	5420061235831	€ 419.00
BB101PSH912045	4500K 120° Black Bridgelux	5420061232472	€ 489.00

*BRUTO WITHOUT VAT/PIECE

150W FLAT FLOODLIGHT 120°

Property	Value
LED Power	150W
System Power	157W
Input Voltage	230V
LED	Spotled Epistar Spotled Super Bridgelux
Light Output	12000lm / 15000lm*
CCT	4500K
Life Span	50000h
CRI	> 80
PF	> 0.96
IP Level	IP65
Beam Angle	120°
Casing Color	Black (other colors on request)
Dimmable	No
Dimensions	187x298x365mm
Cable Length	1.5m
Weight	7.0kg
Certificates	CE, ROHS
Warranty	3 years

* from batch B1436

Goniogram

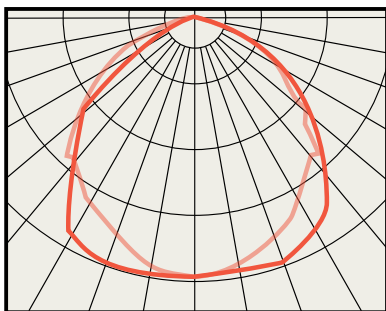

Goniogram for a 120° Fixture



Made
in
Belgium

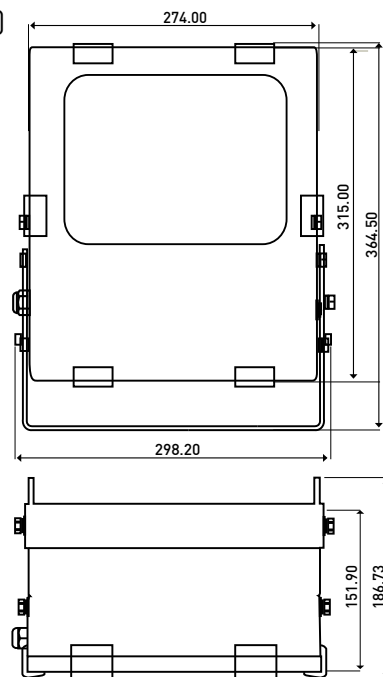

High reliability LED chips by

BRIDGELUX & EPISTAR
The Magic of Light®

References:

Model	Description	GTIN / EAN	Price*
BP151PSH912045	4500K 120° Black Epistar	5420061235848	€ 619.00
BB151PSH912045	4500K 120° Black Bridgelux	5420061232489	€ 739.00

*BRUTO WITHOUT VAT/PIECE

ACCESSORIES FOR FLOODLIGHTS

BRACKET FOR 70W FLOODLIGHT

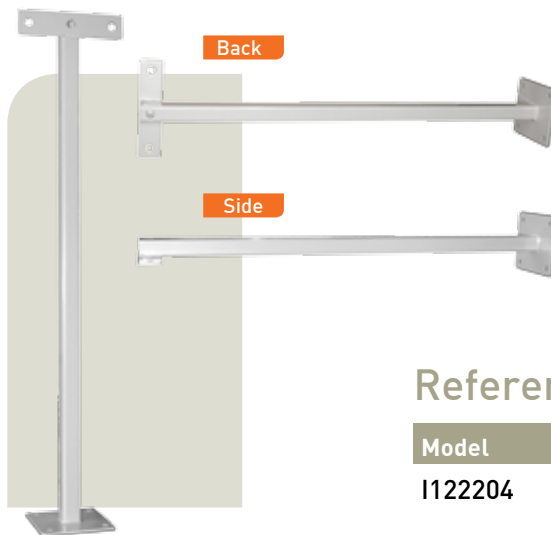

Measures

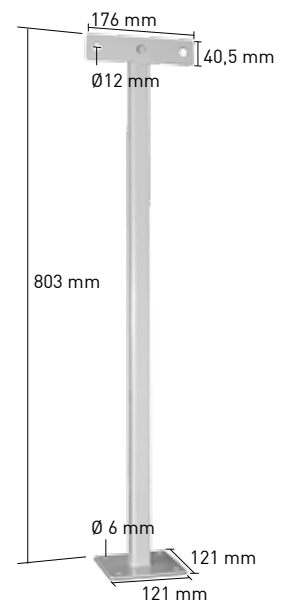

Reference:

Model	Price*
I122204	€ 69.00

PLASTIC SPIKE FOR 10W FLOODLIGHT

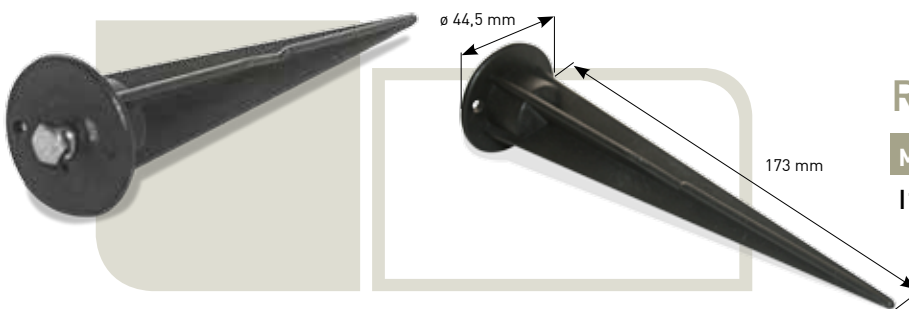

Reference:

Model	Price*
I122205	€ 9.00

STAINLESS STEEL ARM

Property

Stainless Steel Arm
750x20mm with
M10 hole and 30x30x100
mounting brackets



Reference:

Model	GTIN / EAN	Price*
ZINOXBRA020750	5420061216540	€ 79.90

Floodlights for special applications

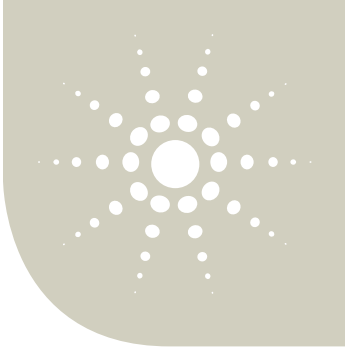
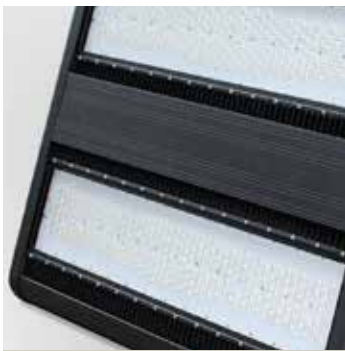

100W LED FLOODLIGHT

Property	Value
LED Power	100W
System Power	110W
Input Voltage	90-305VAC / 50-60Hz
PSU/Driver	Meanwell HLG Series
LED	Edison
Light Output	10000lm
CCT	5000K (3000K on request)
Life Span	50000h
CRI	> 80
PF	> 0.95
IP Level	IP65
Beam Angle	60° (other beam angles on request, see p.32)
Casing Color	Black
Dimmable	In option
Dimensions	387x366x91mm
Cable Length	2m
Weight	8kg
Certificates	ETL, TUV GS, CB, FCC, TUV CE, SAA, PSE, ROHS
Warranty	3 years

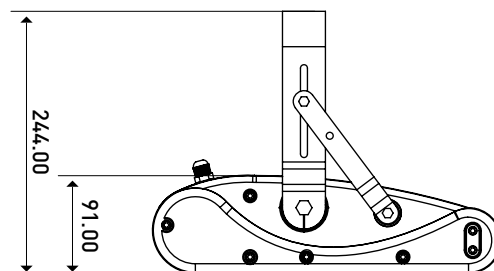
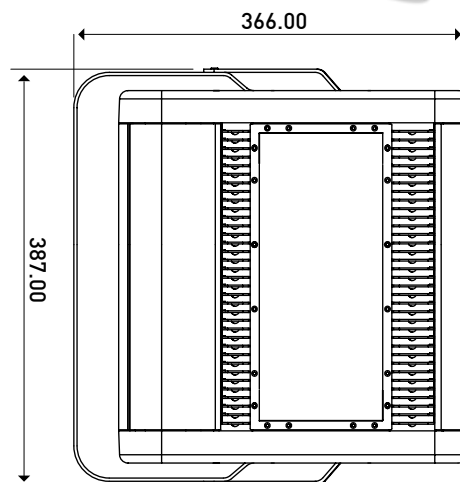

Reference:

Model	Description	GTIN / EAN	Price*
LE100PSH906050	100W-Edison-60°-5000K	542006123196	€ 619.00

*BRUTO WITHOUT VAT/PIECE

150W - 200W LED FLOODLIGHT

Property	Value
LED Power	150W - 200W
System Power	165W - 220W
Input Voltage	90-305VAC / 50-60Hz
PSU / Driver	Meanwell HLG Series
LED	Edison
Light Output	15000lm - 25000lm
CCT	5000K (3000K on request)
Life Span	50000h
CRI	> 80
PF	> 0.95
IP Level	IP65
Beam Angle	60° (other beam angles on request, see p.32)
Casing Color	Black
Dimmable	In option
Dimensions	507x366x91mm
Cable Length	2m
Weight	9.6 - 9.8kg
Certificates	ETL, TUV GS, CB, FCC, TUV CE, SAA, PSE, ROHS
Warranty	3 years

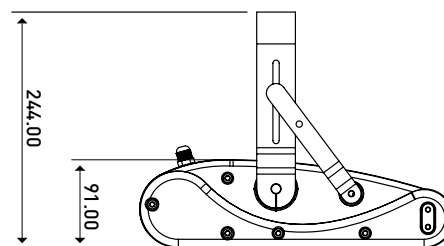
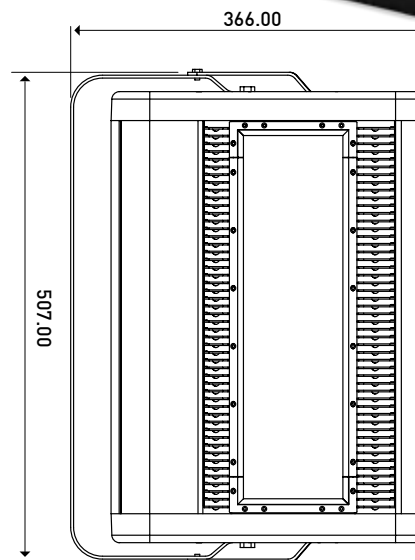

References:

Model	Description	GTIN / EAN	Price*
LE150PSH906050	150W-Edison-60°-5000K	542006123197	€ 769.00
LE200PSH906050	200W-Edison-60°-5000K	542006123198	€ 879.00

*BRUTO WITHOUT VAT/PIECE

250W LED FLOODLIGHT

Property	Value
LED Power	250W
System Power	275W
Input Voltage	90-305VAC / 50-60Hz
PSU / Driver	Meanwell HLG Series
LED	Edison
Light Output	25000lm
CCT	5000K (3000K on request)
Life Span	50000h
CRI	> 80
PFC	> 0.95
IP Level	IP65
Beam Angle	60° (other beam angles on request, see p.32)
Casing Color	Black
Dimmable	In option
Dimensions	567x366x91mm
Cable Length	2m
Weight	9.6kg
Certificates	ETL, TUV GS, CB, FCC, TUV CE, SAA, PSE, ROHS
Warranty	3 years

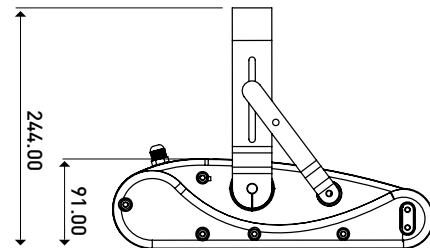
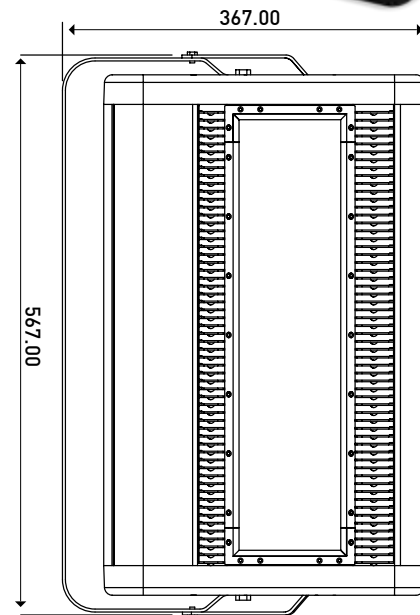

Reference:

Model	Description	GTIN / EAN	Price*
LE250PSH906050	250W-Edison-60°-5000K	542006123281	€ 1139.00

*BRUTO WITHOUT VAT/PIECE

400W LED FLOODLIGHT

Property	Value
LED Power	400W
System Power	440W
Input Voltage	90-305VAC / 50-60Hz
PSU / Driver	Meanwell HLG Series
LED	Edison
Light Output	40000lm
CCT	5000K (3000K on request)
Life Span	50000h
CRI	> 80
PFC	> 0.95
IP Level	IP65
Beam Angle	60° (other beam angles on request, see p.32)
Casing Color	Black
Dimmable	In option
Dimensions	571x606x117mm
Cable Length	2m
Weight	19kg
Certificates	ETL, TUV GS, CB, FCC, TUV CE, SAA, PSE, ROHS
Warranty	3 years

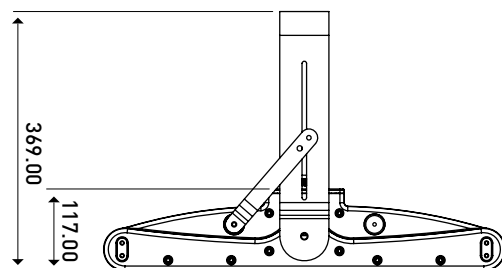
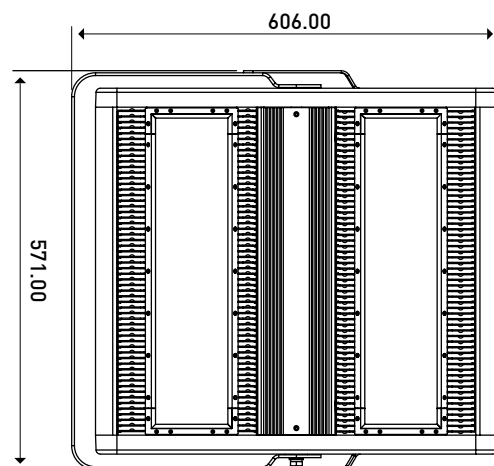

Reference:

Model	Description	GTIN / EAN	Price*
LE400PSH906050	400W-Edison-60°-5000K	542006123200	€ 1899.00

*BRUTO WITHOUT VAT/PIECE

600W LED FLOODLIGHT

Property	Value
LED Power	600W
System Power	660W
Input Voltage	90-305VAC / 50-60Hz
PSU / Driver	Meanwell HLG Series
LED	Edison
Light Output	60000lm
CCT	5000K (3000K on request)
Life Span	50000h
CRI	> 80
PFC	> 0.95
IP Level	IP65
Beam Angle	60° (other beam angles on request, see p.32)
Casing Color	Black
Dimmable	In option
Dimensions	764x623x170mm
Cable Length	2m
Weight	27kg
Certificates	ETL, TUV GS, CB, FCC, TUV CE, SAA, PSE, ROHS
Warranty	3 years

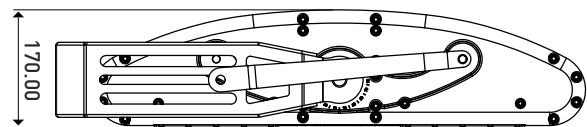
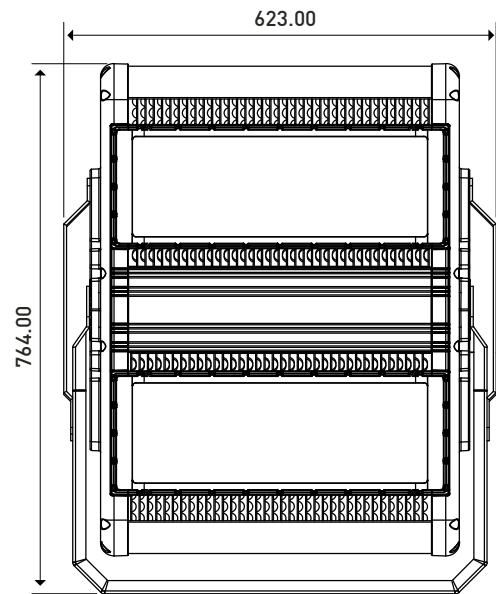

Reference:

Model	Description	GTIN / EAN	Price*
LE600PSH906050	600W-Edison-60°-5000K	542006123201	€ 2299.00

*BRUTO WITHOUT VAT/PIECE

800W LED FLOODLIGHT

Property	Value
LED Power	800W
System Power	880W
Input Voltage	90-305VAC / 50-60Hz
PSU / Driver	Meanwell HLG Series
LED	Edison
Light Output	80000lm
CCT	5000K (3000K on request)
Life Span	50000h
CRI	> 80
PFC	> 0.95
IP Level	IP65
Beam Angle	60° (other beam angles on request, see p.32)
Casing Color	Black
Dimmable	In option
Dimensions	743x764x170mm
Cable Length	2m
Weight	36kg
Certificates	pending
Warranty	3 years

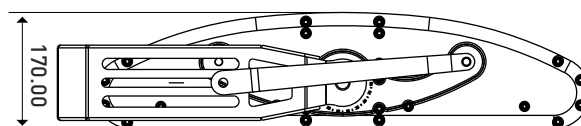
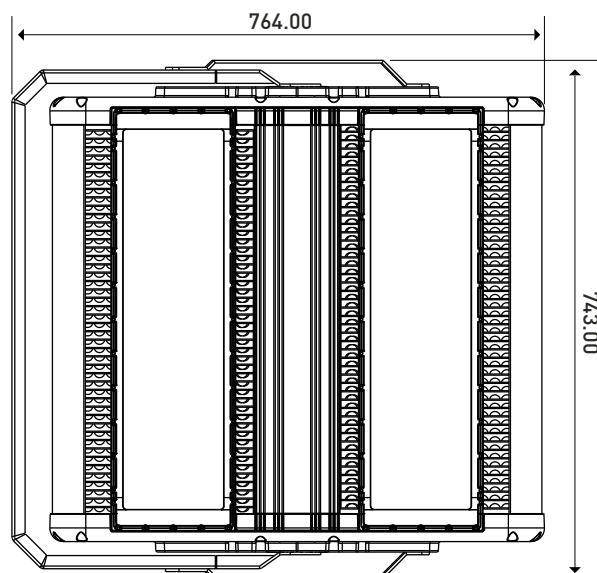

Reference:

Model	Description	GTIN / EAN	Price*
LE800PSH906050	800W-Edison-60°-5000K	542006123202	€ 2799.00

*BRUTO WITHOUT VAT/PIECE

1000W LED FLOODLIGHT

Property	Value
LED Power	1000W
System Power	1100W
Input Voltage	90-305VAC / 50-60Hz
PSU / Driver	Meanwell HLG Series
LED	Edison
Light Output	100000lm
CCT/	5000K (3000K on request)
Life Span	50000h
CRI	> 80
PFC	> 0.95
IP Level	IP65
Beam Angle	60° (other beam angles on request, see p.32)
Casing Color	Black
Dimmable	In option
Dimensions	833x764x170mm
Cable Length	2m
Weight	40kg
Certificates	pending
Warranty	3 years

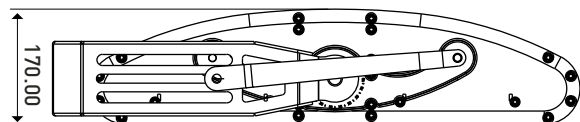
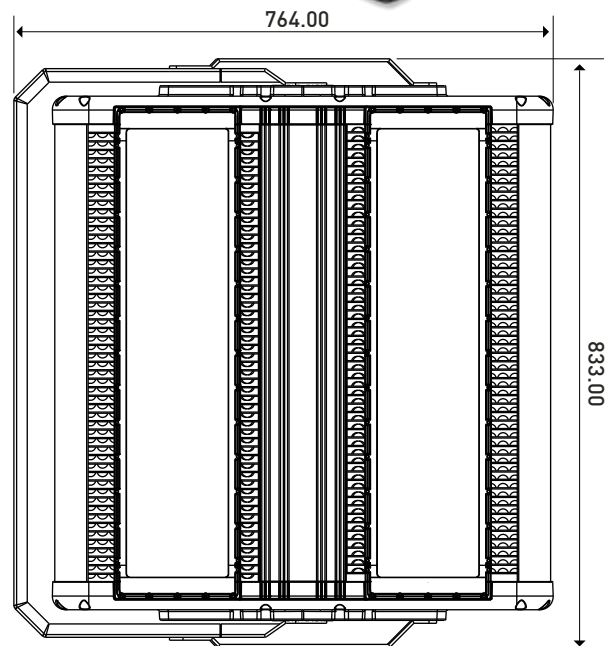

Reference:

Model	Description	GTIN / EAN	Price*
LE1K0PSH906050	1000W-Edison-60°-5000K	542006123203	€ 3419.00

*BRUTO WITHOUT VAT/PIECE

PHOTOMETRIC DISTRIBUTION OF SPECIAL FLOODLIGHTS

Symetric beam angle

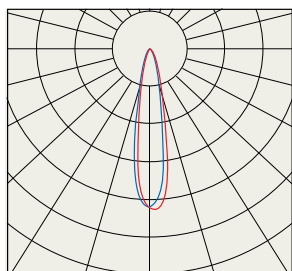

15°x15°

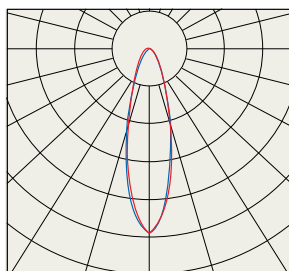

30°x30°

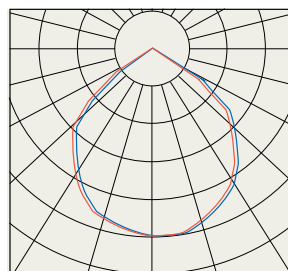

120°x120°

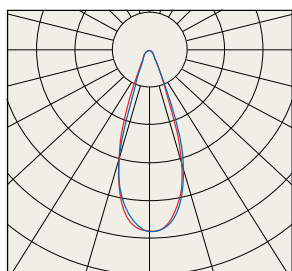

40°x40°

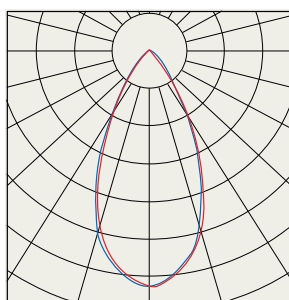

60°x60°

Asymetric beam angle

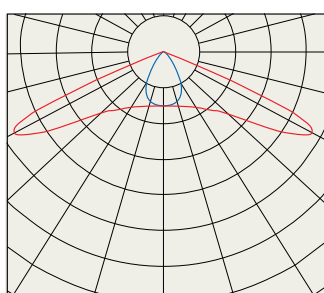

60°x135°

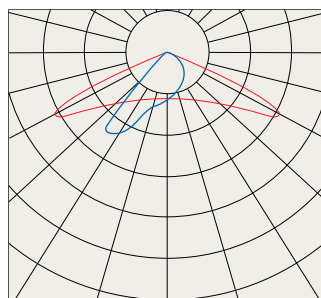

85°x135°

Beam angle code	Description	In model number
015	15x15° symetric beam angle	LEXXP SH9015XX
030	30x30° symetric beam angle	LEXXP SH9030XX
040	40x40° symetric beam angle	LEXXP SH9040XX
060	60x60° symetric beam angle	LEXXP SH9060XX
120	120x120° symetric beam angle	LEXXP SH9120XX
E60	65x135° asymetric beam angle	LEXXP SH9E60XX
E85	85x135° asymetric beam angle	LEXXP SH9E85XX
Color Code		
LEXXP SH912030		30 → 3000K
LEXXP SH912050		50 → 5000K

Low & High Bays

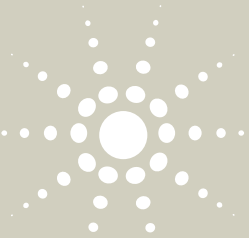

LOW BAY LED CANOPY LIGHT

Property	Value
LED Power	120W
System Power	132W
Input Voltage	90-277 VAC, 50/60 Hz
PSU / Driver	Meanwell HLG Series
LED	Edison
LED Qty	60 pcs
Light Output	12000lm
CCT/Color	5000K
Life Span	>50000h
CRI	>80
PF	> 0.95
IP Level	IP65
Beam Angle	60°
Casing Color	White (other colors on request)
Dimmable	In option
Dimensions	400x400x161mm
Cable Length	3m
Weight	6.5 Kg
Certificates	ETL, TUV GS, CB, FCC, TUV CE, SAA, PSE, ROHS
Warranty	3 years
Light Distribution	symmetric /circle spread

Other beam angles on request

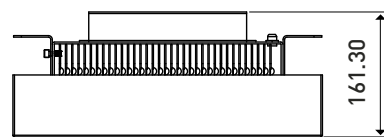
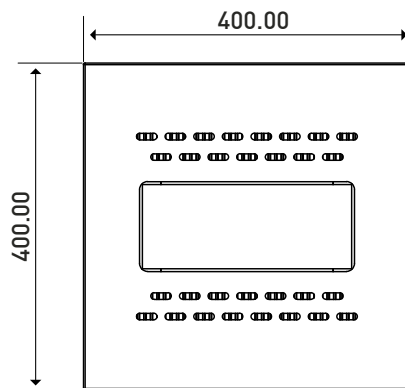

Reference:

Model	Description	GTIN / EAN	Price*
1122174	12000lm 5000K IP65	5420061221742	€ 799.00

*BRUTO WITHOUT VAT/PIECE

HIGH BAY LED LIGHTS 100W - 150W

Property	Value
LED Power	100W-150W
System Power	110W-165W
Input Voltage	90-305VAC / 50-60Hz
PSU / Driver	Meanwell HLG Series
LED	Edison
Light Output	9000lm-13500lm
CCT	5000K
Life Span	>50000h
CRI	>80
PF	> 0.95
IP Level	IP65
Casing Color	Silver
Dimmable	In option
Cable Length	3m
Weight	7.2-7.4kg
Certificates	ETL, TUV GS, CB, FCC, TUV CE, SAA, PSE, ROHS
Warranty	3 years

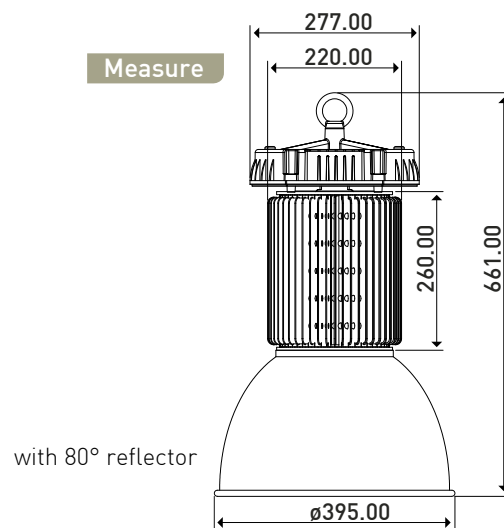

References:

Model	Description	GTIN / EAN	Price*
LE100HSH9XXX50	100W-Edison-5000K-No reflector	542006123183	€ 499.00
LE150HSH9XXX50	150W-Edison-5000K-No reflector	542006123184	€ 589.00

*BRUTO WITHOUT VAT/PIECE

Reflector : choose on page 38

HIGH BAY LED LIGHTS 200W - 250W

Property	Value
LED Power	200W-250W
System Power	220W-280W
Input Voltage	90-305VAC / 50-60Hz
PSU / Driver	Meanwell HLG Series
LED	Edison
Light Output	18000lm-22500lm
CCT	5000K
Life Span	>50000h
CRI	>80
PF	> 0.95
IP Level	IP65
Casing Color	Silver
Dimmable	In option
Cable Length	3m
Weight	10 - 11 kg
Certificates	ETL, TUV GS, CB, FCC, TUV CE, SAA, PSE, ROHS
Warranty	3 years

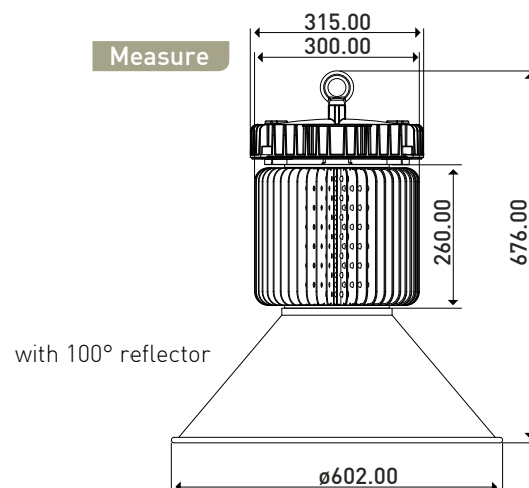

References:

Model	Description	GTIN / EAN	Price*
LE200HSH9XXX50	200W-Edison-5000K-No reflector	542006123185	€ 749.00
LE250HSH9XXX50	250W-Edison-5000K-No reflector	542006123186	€ 979.00

*BRUTO WITHOUT VAT/PIECE

Reflector : choose on page 38

HIGH BAY LED LIGHTS 300W - 350W - 400W

Property	Value
LED Power	300W-350W-400W
System Power	330W-390W-440W
Input Voltage	90-305VAC / 50-60Hz
PSU / Driver	Meanwell HLG Series
LED	Edison
Light Output	27000lm-31500lm-36000lm
CCT/Color	5000K
Life Span	>50000h
CRI	>80
PFC	> 0.95
IP Level	IP65
Casing Color	Silver
Dimmable	In option
Cable Length	3m
Weight	17.6 - 17.6 - 18 kg
Certificates	ETL, TUV GS, CB, FCC, TUV CE, SAA, PSE, ROHS
Warranty	3 years

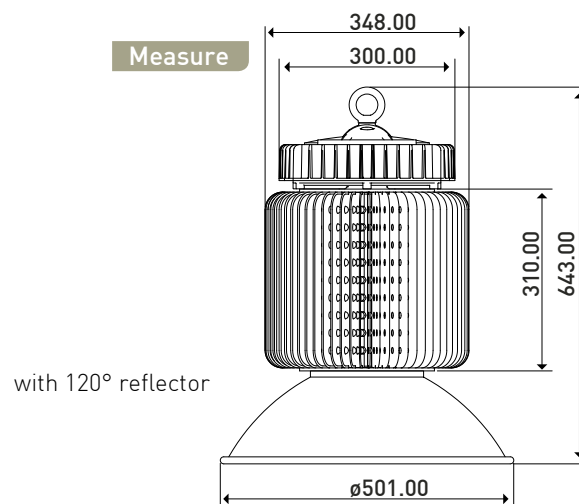

References:

Model	Description	GTIN / EAN	Price*
LE300HSH9XXX50	300W-Edison-5000K-No reflector	542006123187	€ 1319.00
LE350HSH9XXX50	350W-Edison-5000K-No reflector	542006123188	€ 1429.00
LE400HSH9XXX50	400W-Edison-5000K-No reflector	542006123189	€ 1559.00

*BRUTO WITHOUT VAT/PIECE

Reflector : choose on page 38

ACCESSORIES FOR HIGH BAY LIGHTS

80° Reflector

Aluminum Reflector



LREFAL080001102

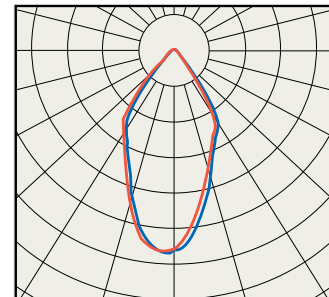
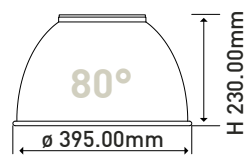

Polycarbonate Reflector



LREFPC080001101

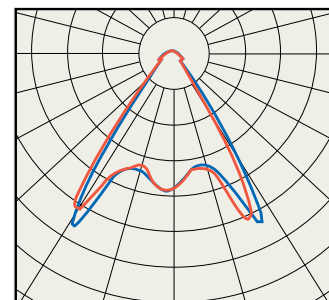

100° Reflector

Aluminum Reflector



LREFAL100001103

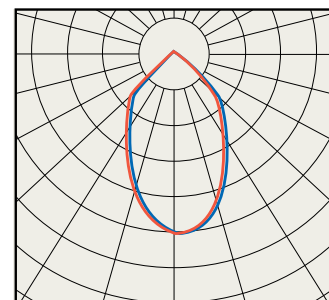
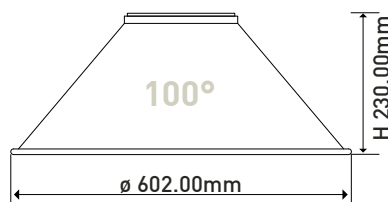

References:

Model	Description	GTIN / EAN	Price*
LREFPC080001101	Polycarbonate Reflector for High Bays 80°	542006123190	€ 39.00
LREFAL080001102	Aluminum Reflector for High Bays 80°	542006123191	€ 39.00
LREFAL100001103	Aluminum Reflector for High Bays 100°	542006123192	€ 39.00

*BRUTO WITHOUT VAT/PIECE

120° Reflector

Aluminum Reflector



LREFAL120001104

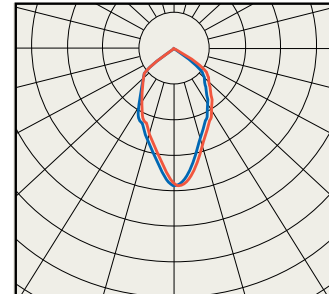
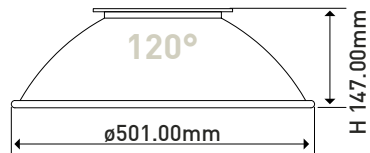

Cover

Bottom glass cover

For reflector



LCOVGC120001202

Frosted Plastic Cover

For LED source



LCOVPF120001301

References:

Model	Description	GTIN / EAN	Price*
LREFAL120001104	Aluminum Reflector for High Bays 120°	542006123193	€ 39.00
LCOVGC080001202	Bottom Glass Cover for High Bays 80°	5420061235381	€ 39.00
LCOVGC100001202	Bottom Glass Cover for High Bays 100	5420061235374	€ 39.00
LCOVGC120001202	Bottom Glass Cover for High Bays 120°	5420061231949	€ 39.00
LCOUPF120001301	Frosted Plastic Cover for High Bays	5420061231956	€ 39.00

*BRUTO WITHOUT VAT/PIECE







Ceiling LED
Tiles

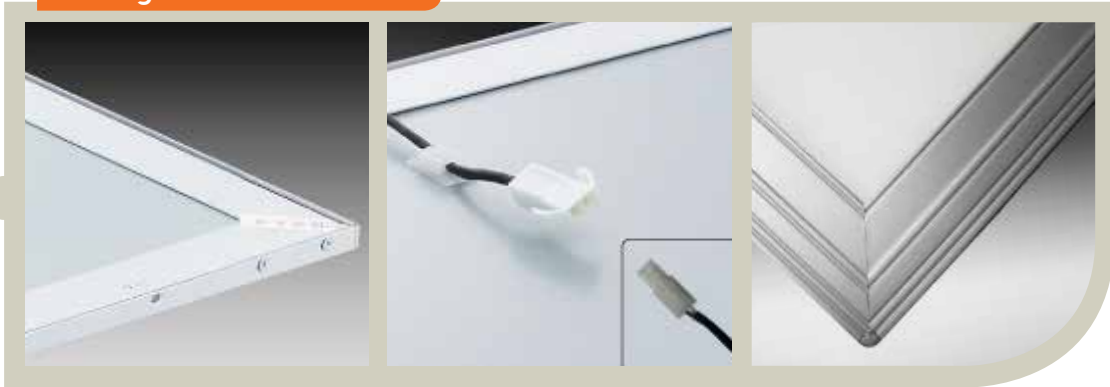

Ceiling LED Tile details



- Manufactured with Samsung 4014 SMD LEDs 
- CRI: 80+
- Efficiency: 90lm/W
- Delivered with high efficiency constant current drivers
- Even light distribution

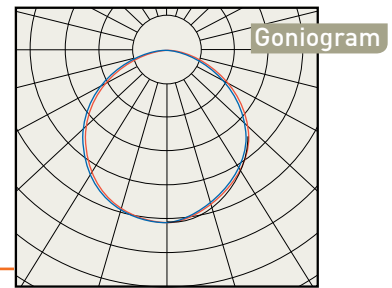

CPSURFMOUNTKIT

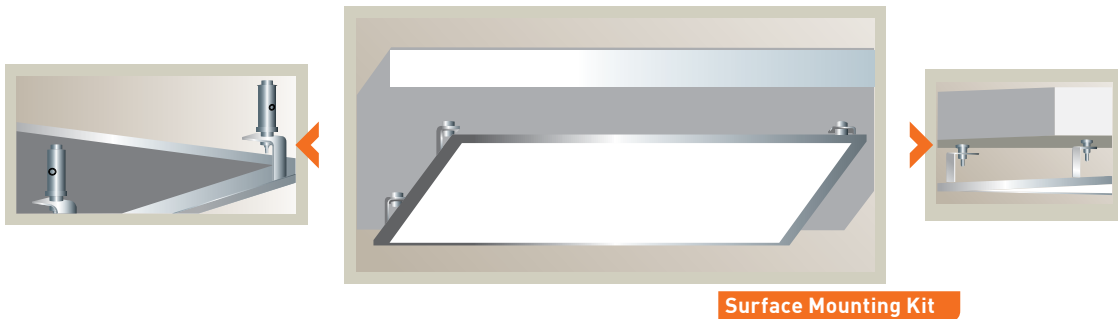

CPWIHANGINGKIT

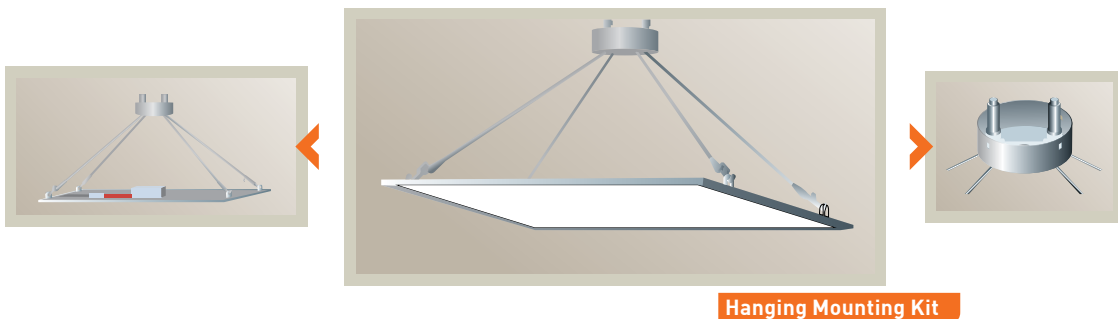

References:

Model	Description	GTIN / EAN	Price*
CPSURFMOUNTKIT	Surface Mounting Kit	5420061211682	€ 29.00
CPWIHANGINGKIT	Wire Hanging Kit	5420061211675	€ 29.00

*BRUTO WITHOUT VAT/PIECE

30 X 30 900LM CEILING LED TILE

Property	Value
Power	12W
Voltage	230V / ext.PSU
Power Fact.	0.96
Intensity	900lm
Angle	120°
CCT/Color	3000K / 4000K
CRI	>80
IPLevel	IP20
Dimensions	295x295x8mm
Frame Color	Silver
Dimmable	No
LED	Samsung 5630 SMD



References:

Model	Description	GTIN / EAN	Price*
CG012NSH030330	30x30cm 900lm 3000K silver frame	5420061232045	€ 89.00
CG012NSH030340	30x30cm 900lm 4000K silver frame	5420061232052	€ 89.00

*BRUTO WITHOUT VAT/PIECE

60 X 60 3600LM CEILING LED TILE

Property	Value
Power	40W
Voltage	230V / ext.PSU
Power Fact.	0.96
Intensity	3300lm / 3600lm
Angle	120°
CCT/Color	3000K / 4000K
CRI	>80
IPLevel	IP20
Dimensions	595x595x8mm
Frame Color	Silver
Dimmable	Yes
LED	Samsung 4014 SMD

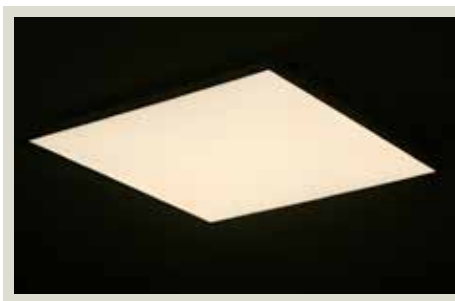
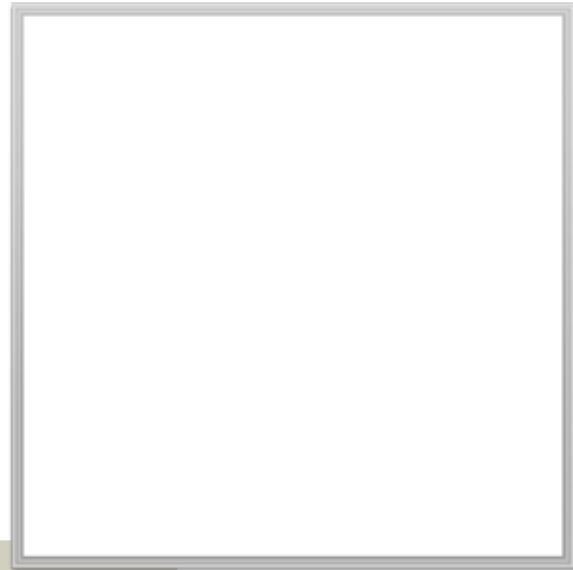

References:

Model	Description	GTIN / EAN	Price*
CG041NDE060630	60x60cm 3300lm 3000K silver frame	5420061232076	€ 204.00
CG041NDE060640	60x60cm 3600lm 4000K silver frame	5420061232083	€ 204.00

*BRUTO WITHOUT VAT/PIECE

120 X 30 3600LM CEILING LED TILE

Property	Value
Power	40W
Voltage	230V / ext.PSU
Power Fact.	0.96
Intensity	3300lm / 3600lm
Angle	120°
CCT/Color	3000K / 4000K
CRI	>80
IPLevel	IP20
Dimensions	1195x295x8mm
Frame Color	Silver
Dimmable	Yes
LED	Samsung 4014 SMD



References:

Model	Description	GTIN / EAN	Price*
CG041NDE120330	120x30cm 3300lm 3000K silver frame	5420061232106	€ 204.00
CG041NDE120340	120x30cm 3600lm 4000K silver frame	5420061232113	€ 204.00

*BRUTO WITHOUT VAT/PIECE





Flexible LED Strips



Non Waterproof Flexible LED Strip

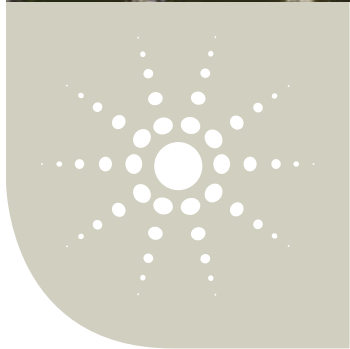

NON WATERPROOF FLEXIBLE LED STRIP 60 LED 3528/M 22W

Property	Value
Power max	22W/5m
Voltage	12VDC
LED	3528
LED/m	60 LED/m
Light Output	360lm/m
CRI	90
Dimensions	5000x8x2.5mm
Cutting section	49.5mm
IP Level	IP20
Double side tape	Yes

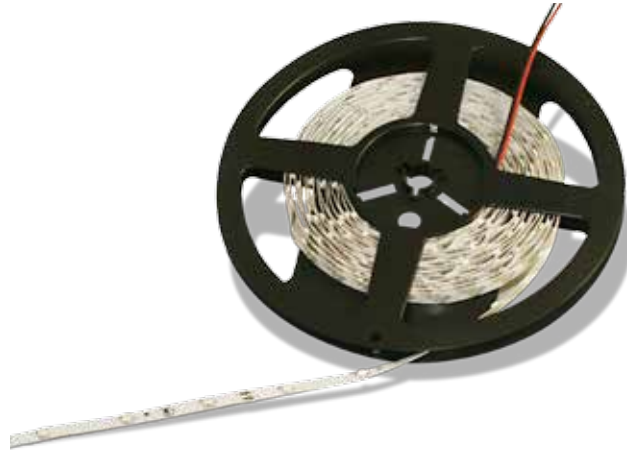

Detail



1 bin/Reel
bin specified
on each reel

Light Effects :



References:

Model	Description	GTIN / EAN	Price*
UP022EDL912027	Warm White 2700K	5420061233424	€ 59.00
UP022EDL912030	Warm White 3000K	5420061235060	€ 59.00
UP022EDL912045	Neutral White 4500K	5420061233752	€ 59.00
UP022EDL912060	Cool White 6000K	5420061233769	€ 59.00

*BRUTO WITHOUT VAT/PIECE

NON WATERPROOF FLEXIBLE LED STRIP 120 LED 3528/M 45W

Property	Value
Power max	45W/5m
Voltage	12VDC
LED	3528
LED/m	120 LED/m
Light Output	720lm/m
CRI	90
Dimensions	5000x8x2.2mm
Cutting section	25mm
IP Level	IP20
Double side tape	yes



Detail

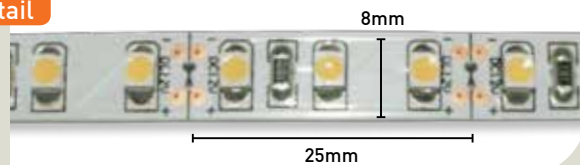

1 bin/Reel
bin specified
on each reel

Light Effects :



References:

Model	Description	GTIN / EAN	Price*
UP045EDL912027	Warm White 2700K	5420061235572	€ 84.00
UP045EDL912030	Warm White 3000K	5420061235589	€ 84.00
UP045EDL912045	Neutral White 4500K	5420061235596	€ 84.00
UP045EDL912060	Cool White 6000K	5420061235602	€ 84.00

*BRUTO WITHOUT VAT/PIECE

NON WATERPROOF FLEXIBLE LED STRIP 72 LED 3014/M 44W

Property	Value
Power max	44W/5m
Voltage	24VDC
LED	3014
LED/m	72 LED/m
Light Output	630-630-670-710lm/m
CRI	90
Dimensions	5000x10x1mm
Cutting section	83.3m
IP Level	IP20
Double side tape	yes

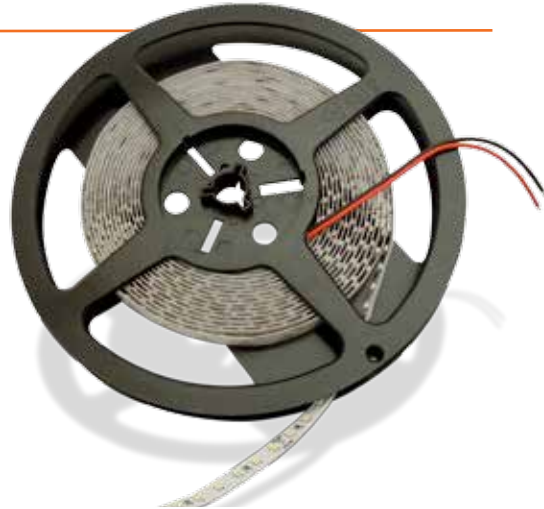

Detail



1 bin/Reel
bin specified
on each reel

Light Effects :



References:

Model	Description	GTIN / EAN	Price*
UP044EDN912027	Warm White 2700K	5420061222695	€ 99.00
UP044EDN912030	Warm White 3000K	5420061235053	€ 99.00
UP044EDN912045	Neutral White 4500K	5420061222701	€ 99.00
UP044EDN912060	Cool White 6000K	5420061222718	€ 99.00

*BRUTO WITHOUT VAT/PIECE

NON WATERPROOF FLEXIBLE LED STRIP 120 LED 3014/M 72W

Property	Value
Power max	72W/5m
Voltage	24VDC
LED	3014
LED/m	120 LED/m
Light Output	950-950 1000-1100lm/m
CRI	90
Dimensions	5000x10x1mm
Cutting section	50mm
IP Level	IP20
Double side tape	yes

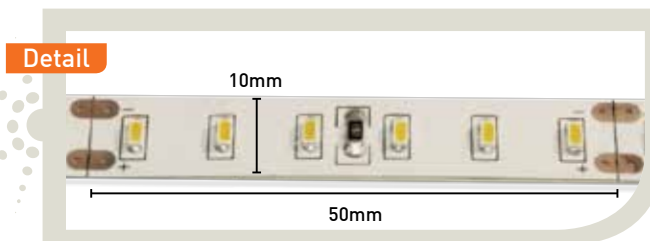

1 bin/Reel
bin specified
on each reel

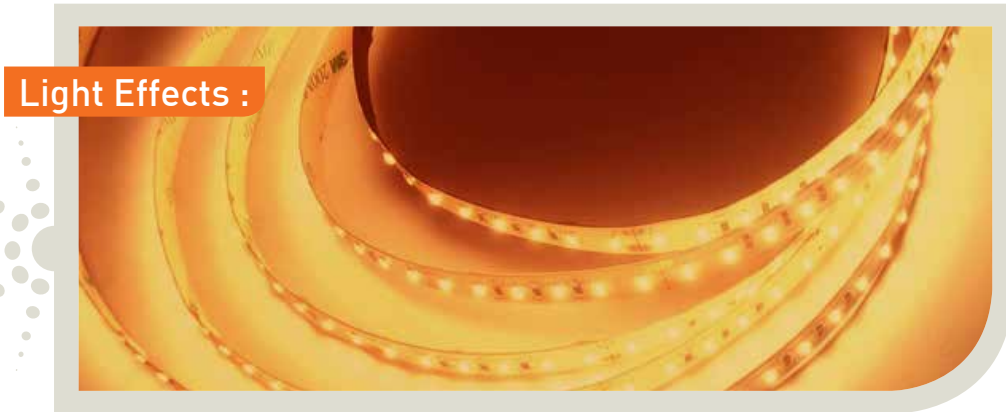

References:

Model	Description	GTIN / EAN	Price*
UP072EDN912027	Warm White 2700K	5420061222329	€ 149.00
UP072EDN912030	Warm White 3000K	5420061222725	€ 149.00
UP072EDN912045	Neutral White 4500K	5420061222336	€ 149.00
UP072EDN912060	Cool White 6000K	5420061222343	€ 149.00

*BRUTO WITHOUT VAT/PIECE

NON WATERPROOF FLEXIBLE LED STRIP 180 LED 3014/M 108W

Property	Value
Power max	108W/5m
Voltage	24VDC
LED	3014
LED/m	180 LED/m
Light Output	1550-1550-1650-1700-1600lm/m
CRI	90
Dimensions	5000x8x1mm
Cutting section	33.3mm
IP Level	IP20
Double side tape	yes



Detail

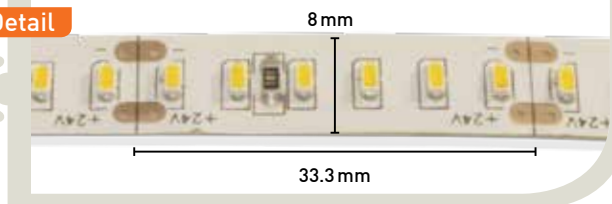

1 bin/Reel
bin specified
on each reel

Light Effects :



References:

Model	Description	GTIN / EAN	Prices*
UP108EDN912027	Warm White 2700K	5420061222312	€ 199.00
UP108EDN912030	Warm White 3000K	5420061233936	€ 199.00
UP108EDN912045	Neutral White 4500K	5420061222350	€ 199.00
UP108EDN912060	Cool White 6000K	5420061222367	€ 199.00
UP108EDN91202C	Dual White 2700K-6000K	5420061231819	€ 199.00

*BRUTO WITHOUT VAT/PIECE

NON WATERPROOF FLEXIBLE LED STRIP 84 LED 5630/M 133W

Property	Value
Power max	133W/5m
Voltage	24VDC
LED	5630
LED/m	84 LED/m
Light Output	2200-2200- 2300-2400lm/m
CRI	80
Dimensions	5000X10X2mm
Cutting section	83.3mm
IP Level	IP20
Double side tape	yes



Detail

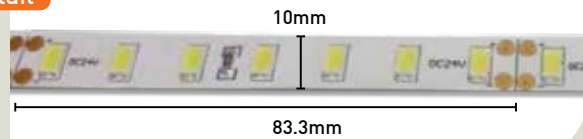

1 bin/Reel
bin specified
on each reel

Light Effects :



References:

Model	Description	GTIN / EAN	Prices*
UG115EDN912027	Warm White 2700K	5420061233929	€ 199.00
UG115EDN912030	Warm White 3000K	5420061232809	€ 199.00
UG115EDN912045	Neutral White 4500K	5420061232793	€ 199.00
UG115EDN912060	Cool White 6000K	5420061232786	€ 199.00

*BRUTO WITHOUT VAT/PIECE

NON WATERPROOF FLEXIBLE LED STRIP 30 LED 5050/M (RGB) 36W

Property	Value
Power max	36W/5m
Voltage	12VDC
LED	5050
LED/m	30 LED/m
Dimensions	5000x10x2mm
Cutting section	100mm
IP Level	IP20
Double side tape	yes



Detail



1 bin/Reel
bin specified
on each reel

Light Effects :



Reference:

Model	Description	GTIN / EAN	Price*
IP036EDL91203C	RGB 30 LED/m	5420061213884	€ 139.00

*BRUTO WITHOUT VAT/PIECE

NON WATERPROOF FLEXIBLE LED STRIP 60 LED 5050/M (RGB) 72W

Property	Value
Power max	72W/5m
Voltage	24VDC
LED	5050
LED/m	60 LED/m
Dimensions	5000x10x2mm
Cutting section	100mm
IP Level	IP20
Double side tape	yes



Detail

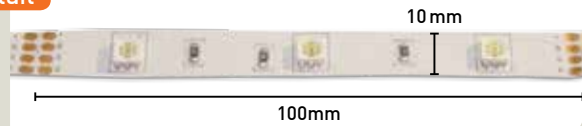

1 bin/Reel
bin specified
on each reel

Light Effects :



Reference:

Model	Description	GTIN / EAN	Price*
UP055EDN91203C	RGB 60 LED/m	5429961235886	€ 149.00

*BRUTO WITHOUT VAT/PIECE

NON WATERPROOF FLEXIBLE LED STRIP 60 LED 5050/M 72W

Property	Value
Power max	72W/5m
Voltage	24VDC
LED	5050
LED/m	60 LED/m
Light Output	800lm/m
CRI	80 (white)
Dimensions	5000x10x2mm
Cutting section	99mm
IP Level	IP20
Double side tape	yes



Detail

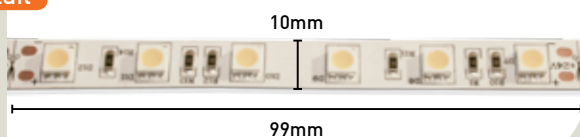

1 bin/Reel
bin specified
on each reel

Light Effects :

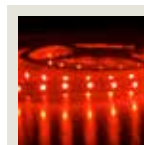

References :

Model	Description	GTIN / EAN	PRICES*
UP055EDN912030	Warm White 3000K	5420061222886	€ 129.00
UP055EDN912045	Neutral White 4500K	5420061231628	€ 129.00
UP055EDN912060	Cool White 6000K	5420061235619	€ 129.00
UP055EDN9120RB	Royal Blue	5420061234001	€ 149.00
UP055EDN9120CB	Cyan Blue	5420061234018	€ 149.00
UP055EDN9120GR	Green	5420061234025	€ 149.00
UP055EDN9120CR	Cherry Red	5420061234063	€ 149.00

*BRUTO WITHOUT VAT/PIECE

LED strip connectors

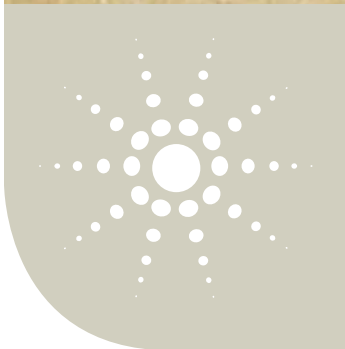
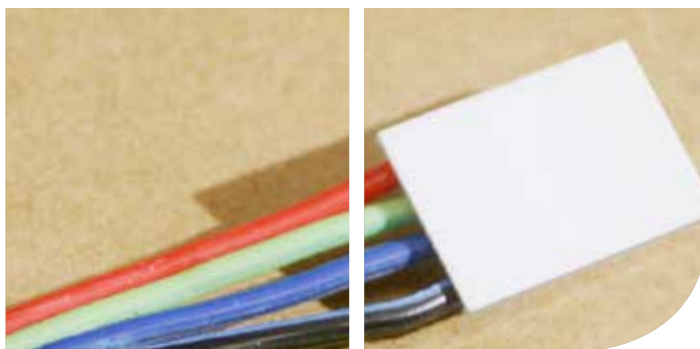

SOLDERLESS CONNECTORS

Property	Value
Rated Current	2.5A
Voltage	12V/24V, according to LED strip voltage
Dimensions	11x15x3mm

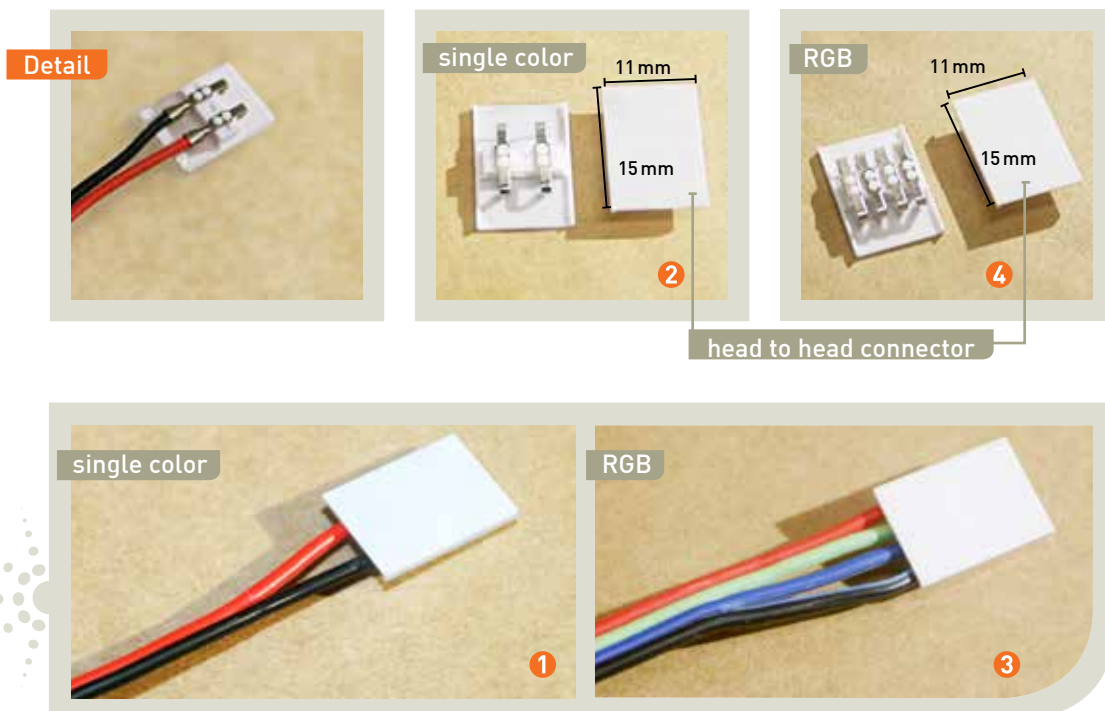

References:

Model	Description	GTIN / EAN	Price*
TC2WIRES2STRIP 1	Slim clip on flat solderless connector IP20 flat for 8&10mm single color strip with wires	5420061233837	€ 3.15
TC2STRIP2STRIP 2	Slim clip on flat solderless head to head connector IP20 for 8&10mm single color strip	5420061233844	€ 2.10
TC4WIRES2STRIP 3	Slim clip on flat solderless connector IP20 flat for 8&10mm RGB strip with wires	5420061233851	€ 3.85
TC4STRIP2STRIP 4	Slim clip on flat solderless head to head connector IP20 for 8&10mm RGB strip	5420061233875	€ 2.80

*BRUTO WITHOUT VAT/PIECE





Controllers



Controllers

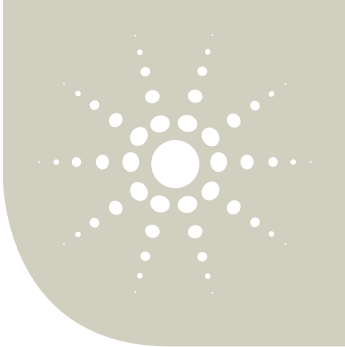
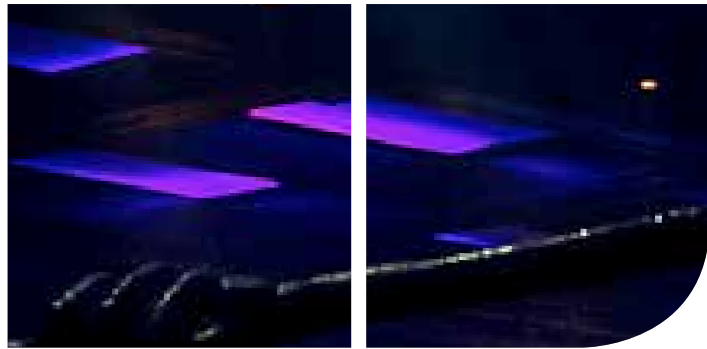

SPOTLED LIGHT CONTROL KIT COLOR WHEEL REMOTE CONTROL & RECEIVER

With 3x5A RGB LED Controller

Remote

Property	Value
Power	0.15W
Voltage	5VDC (USB charge)
Current	30mA
Control	18 buttons
Range	30m on 2.4 GHz
Standby Time	1 year
Use Time	30 days
Charge Time	4 hours
Charge Cycles	500
Dimensions	145x55x22mm
Casing Color	White
Weight	200g



Receiver

Property	Value
Power	180 / 360W
Voltage	12/ 24V
Current	3x5A
Control	8 buttons
Resolution	65536 levels / color
Dimensions	211x40x30mm
Weight	180g

MAIN FEATURES :

- > Touch sensitive intuitive remote control
- > 16 bits per channel color resolution
- > USB charging port for the remote
- > Switch, Pause, Play, Dimming functions
- > 30m range
- > Sleek design
- > Reliable

Reference:

Model	GTIN / EAN	Price*
J_RGBREMCTRLRW	5420061209511	€ 179.00

*BRUTO WITHOUT VAT/PIECE

SPOTLED LIGHT CONTROL REMOTE CONTROL

T1 T2M T3M

Property	Value
Input voltage	DC5V built-in Lithium battery
Working current	≤ 30mA
Working frequency	2.4GHZ
transmitting distance	30m
Remote option	Sync or zone control
Scale levels/chanel	1024
Battery capacity	1000mAh
Standby time	≤ 6 months
Dimension	L145xW55xH22mm
Package Size	L168xW102xH28mm
Weight (G.W)	200g



4 channels upon order

References:

Model	Description	GTIN / EAN	Price*
SPDREMOTECWT1M	1 channel 8 zones	5420061231314	€ 89.90
SPDREMOTECWT2M	2 channels 8 zones	5420061231338	€ 99.90
SPDREMOTECWT3M	3 channels 10 zones	5420061231352	€ 129.90

*BRUTO WITHOUT VAT/PIECE

SPOTLED LIGHT CONTROL CONSTANT VOLTAGE RECEIVER

Property	Value
Input voltage	DC5V-DC24V
Max current load	6Ax3CH Max 18A
Max output power	90W/216W/432W (5V/12V/24V)
Compatible remote control	T1/T2/T2M/T3/T3M/T3X remote control
Dimension	L175xW44xH30(mm)
Package size	L178xW48xH33mm
Weight (G.W.)	150g



Reference:

Model	Description	GTIN / EAN	Price*
SPDRECEIVET3CV	Remote control receiver constant voltage	5420061231406	€ 89.90

*BRUTO WITHOUT VAT/PIECE

SPOTLED LIGHT CONTROL CONSTANT CURRENT RECEIVER

Property	Value
Input voltage	DC12V-DC48V
Output voltage	DC3V-DC46V
Output current	CC 350/700/1050mAx3CH
Output power	1.05W~48.3Wx3CH Max 144.9W
Compatible remote control	T1/T2/T2M/T3/T3M/T3X remote control
Dimension	L175xW44xH30(mm)
Package size	L178xW48xH33mm
Weight (G.W.)	160g



Reference:

Model	Description	GTIN / EAN	Price*
SPDRECEIVET3CC	Remote control receiver constant current	5420061231383	€ 89.90

*BRUTO WITHOUT VAT/PIECE

SPOTLED LIGHT CONTROL CONSTANT VOLTAGE RECEIVER WITH BUTTONS

Property	Value
Input voltage	DC12V-DC24V
Max current load	5Ax3CH Max 15A
Max output power	180W/360W(12V/24V)
Control button	8 touch buttons
Compatible remote control	workable with T3, T3M, T3X
Working temperature	-30°C~55°C
Dimension	L211xW40xH30mm
Package size	L215xW42xH32mm
Weight (G.W.)	180g

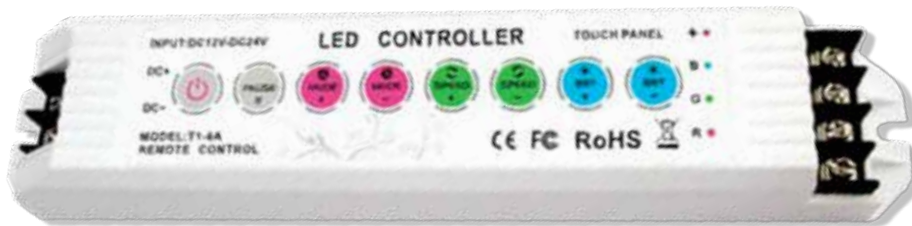

Reference:

Model	Description	GTIN / EAN	Price*
SPDRECEIVET25A	Touch button constant voltage	5420061231376	€ 79.90

*BRUTO WITHOUT VAT/PIECE

SPOTLED LIGHT CONTROL D SERIES TOUCH PANEL CONTROLLER

- › Attractive Design
- › Easy to Install
- › High touching accuracy
- › Easy to use and intuitive
- › T-PWM technology for smooth and accurate dimming and color mixing

Property	Value		
SPD TOUCH PPWM	D1	D2	D3
Input Voltage	12/24VDC		
Max Current Load	4Ax3Ch	4Ax2ch	4Ax3Ch
Max Output Power	144/288W	96/192W	144/288W
Dimensions	L86xW86xH36		
Package Size	L112xW112xH48		
Weight	210g		



References:

Model	Description	GTIN / EAN	Price*
SPD TOUCH PPWMD1	1 channel touch panel controller	5420061235541	€ 129.00
SPD TOUCH PPWMD2	2 channel touch panel controller	5420061235558	€ 129.00
SPD TOUCH PPWMD3	3 channel touch panel controller	5420061235565	€ 129.00

*BRUTO WITHOUT VAT/PIECE

SPOTLED LIGHT CONTROL POWER AMPLIFIER CONSTANT VOLTAGE

Property	Value
Input signal	PWM
Input voltage	DC5V~DC24V
Max load current	6Ax3CH Max 18A
Max output power	90W/216W/432W (5V/12V/24V)
Dimension	L175xW44xH30(mm)
Package Size	L178xW48xH33(mm)
Weight (G.W)	110g



References:

Model	Description	GTIN / EAN	Price*
SPDPWMP3030CV	Power amplifier	5420061231482	€ 59.90

*BRUTO WITHOUT VAT/PIECE

SPOTLED LIGHT CONTROL POWER AMPLIFIER CONSTANT CURRENT

Property	Value
Input signal	PWM
Input voltage	DC12V~DC48V
Output voltage	DC3V~DC46V
Max load current	CC 350/700/1050mA 3 in 1x3CH
Output power	1.05W~48.3Wx3CH Max 144.9W
Output signal	CC PWM
Dimension	L175xW44xH30(mm)
Package Size	L178xW48xH33(mm)
Weight (G.W)	110g



References:

Model	Description	GTIN / EAN	Price*
SPDPWMP3030CC	Power amplifier	5420061231505	€ 79.90

*BRUTO WITHOUT VAT/PIECE

SUNLITE DMX CONTROLLER STICK 2

Property	Value
Design	Glass
Dimensions	86x86x11mm
Weight	130 g
DMX channels	128
ESA software	PC
ESA2 software	PC / Mac
Number of scenes	24
Number of zones	1
Memory capacity (steps) with 20 chan.	840
Memory capacity (steps) with 60 chan.	310
Power voltage	5V-12V DC
Power connector	Screw terminal block
Live control	Color/Dimmer
Touch-sensitive buttons	3
Port triggering	1



Reference:

Model	Description	GTIN / EAN	Price*
FDMXCTSTICKGU2	Sunlite Stick GU2	5420061211507	€ 299.00

*BRUTO WITHOUT VAT/PIECE

SUNLITE DMX CONTROLLER DE3

Property

Design
Dimensions
Weight
DMX channels
ESA software
ESA2 software
Number of scenes
Number of zones
Memory capacity (steps) with 20 chan.
Memory capacity (steps) with 60 chan.
Power voltage
Power connector
Live control
Touch-sensitive buttons
Port triggering

Value

Glass
 106x146x11mm
 250 g
 2x512
 PC
 PC / Mac
 500
 10
 SD card limit
 SD card limit
 5V-6V DC
 Screw terminal or RJ45
 Color/Dimmer/speed
 20
 8



Reference:

Model	Description	GTIN / EAN	Price*
FDMXCTSTICKDE3	Sunlite Stick DE3	5420061218032	€ 769.00

*BRUTO WITHOUT VAT/PIECE

SPOTLED LIGHT CONTROL DMX 512 INTERFACE

Property

Color
casing
Sockets
Output current

Rated voltage

Value

Black metal
166 x 67 x 41 mm
XLR & RJ 45
3 x 4A 12 - 24V
3X350mA
3X700mA
12-24VDC



References :

Model	Description	GTIN / EAN	Price*
Y_RGBDMXINTXLN	Interface DMX 3x4A, 12 - 24 V	5420061201928	€ 59.00
Y_RGBDMXINTXCC	Interface DMX 12 - 24 V, 3X 350mA	5420061208446	€ 69.00
Y_RGBDMXINTXCD	Interface DMX 12 - 24 V, 3X 700mA	5420061208453	€ 69.00

*BRUTO WITHOUT VAT/PIECE

PUSH BUTTON RGB CONTROLLER

Property	Value
Rated voltage	12-24VDC
Rated current	2 A
Max power	75 - 150 W
Working temperature	1,5 °C
Input cable section	1,5 mm ²
Dimension	151x40x30 mm
Weight	95 g

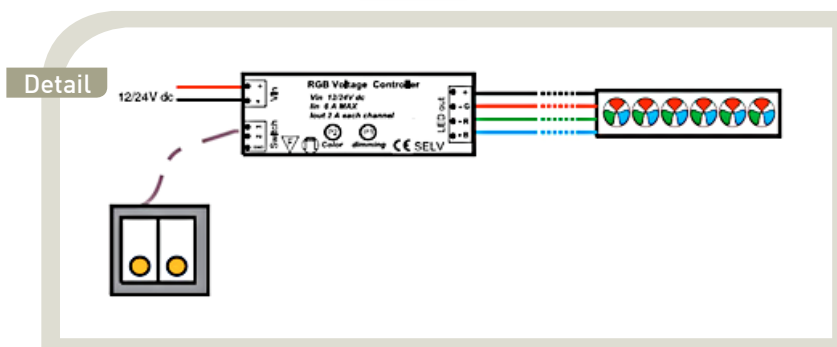

Reference:

Model	Description	GTIN / EAN	Price*
1031355	Push button RGB controller	5420061214997	€ 25.00

*BRUTO WITHOUT VAT/PIECE

DIMMABLE LED CONTROLLER

Property	Value
Rated voltage	12-24VDC
Rated current	8,5 A
Max power	100 - 200 W
Working temperature	0-40 °C
Working temperature (Tc point)	80 °C
Input cable section	1,5 mm ²
Dimension	112x41x20 mm
Weight	62 g

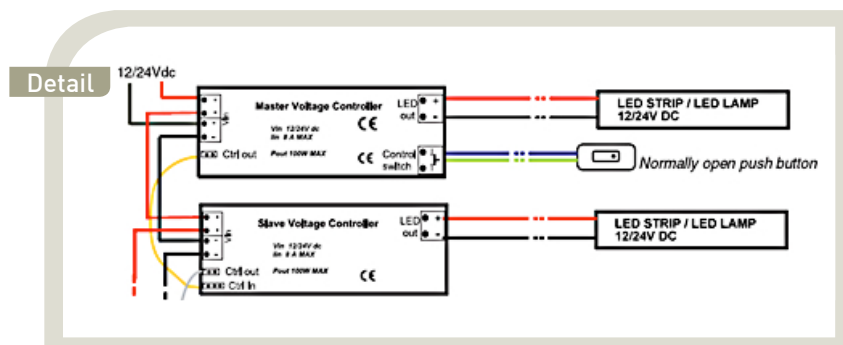

References :

Model	Description	GTIN / EAN	Price*
1032503	Aled-dim Monop-V master	5420061215161	€ 29.00
1032504	Aled-dim Monop-V slave	5420061215178	€ 29.00
1800684	Aled-dim Monop-V master with memory	5420061235923	€ 37.00

*BRUTO WITHOUT VAT/PIECE





Power Supplies



Constant voltage Power Supplies



LOW POWER LIGHTING PSU (CV)

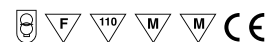

Property

Input voltage

Frequency

IP Level

Mode

PFC

Protection

Warranty

Non dimmable

Value

220V-240V AC

50-60Hz

IP20

Constant Voltage

Depending on model

SC / OC / OV / OT

2 years



References:

Model	Description					GTIN/EAN	Price*
	Output V	Output I	Power	PFC	Size (LxWxH)		
I401295	12	1.67	20W	No	154x50x14mm	5420061215529	€ 16.60
I401296	24	0.84	20W	No	154x50x14mm	5420061215536	€ 16.60
I401292	12	2.5	30W	Yes	160x58x18mm	5420061215499	€ 27.05
I401286	24	1.25	30W	Yes	160x58x18mm	5420061215437	€ 27.05
I401297	12	4.17	50W	Yes	185x64x22mm	5420061215543	€ 39.55
I401298	24	2.08	50W	Yes	185x64x22mm	5420061215550	€ 39.55
I401290	12	6.25	75W	Yes	200x63x30mm	5420061215475	€ 52.25
I401289	24	3.12	75W	Yes	200x63x30mm	5420061215468	€ 52.25

*BRUTO WITHOUT VAT/PIECE

Protection

SC: Short Circuit

OC: Over Current

OV: Over Voltage

OT: Over Temperature

OUTDOOR LIGHTING AND SIGNAGE WITHOUT PFC

WATERPROOF LOW POWER PSU (CV)



Property	Value
Input voltage	90-264VAC / 127-370VDC 180-305VAC / 254-431VDC (for 150W version)
Frequency	50-60Hz
IP Level	IP67
Mode	Constant Voltage
PFC	No
Protection	SC / OC / OV
Warranty	2 years
Non dimmable	



Application: Signage and outdoor lighting

References:

Model	Description				GTIN/EAN	Price*
	Output V	Output I	Power	Size (LxWxH)		
6MWLPV_0200012	12V	1.67A	20W	118x35x26mm	5420061206831	€ 20.00
6MWLPV_0350012	12V	3A	36W	148x40x30mm	5420061207692	€ 28.00
6MWLPV_0600012	12V	5A	60W	162.5x42.5x32mm	5420061200297	€ 32.50
6MWLPV_1000012	12V	8.5A	102W	190x52x37mm	5420061222138	€ 55.75
6MWLPV_1500012	12V	10A	120W	191x63x37.5mm	5420061235510	€ 71.00
6MWLPV_0200024	24V	0.84A	20.2W	118x35x26mm	5420061206848	€ 20.00
6MWLPV_0350024	24V	1.5A	36W	148x40x30mm	5420061207708	€ 28.00
6MWLPV_0600024	24V	2.5A	60W	162.5x42.5x32mm	5420061200303	€ 32.50
6MWLPV_1000024	24V	4.2A	100.8W	190x52x37mm	5420061222220	€ 55.75
6MWLPV_1500024	24V	6.3A	151.2W	191x63x37.5mm	5420061235503	€ 71.00

*BRUTO WITHOUT VAT/PIECE

Available voltages:

5,12,15,24,36,48V
(replace the two last digits of reference with relevant voltage)

Protection

SC: Short Circuit
OC: Over Current
OV: Over Voltage

WATERPROOF LOW POWER PSU (CV + CC)



Property

Input voltage

Frequency

IP Level

Mode

PFC

Protection

Warranty

Value

90-305VAC / 127-431VDC

50-60Hz

IP67

Constant Voltage with Constant Current Region

Yes

SC / OC / OV / OT

2 years



References:

	Model	Description			GTIN/EAN	Price*	
		Output V	Output I	CC Region			Size (LxWxH)
Non dimmable	6MWLPF_0250012	12V	2.1A	6.6-12V	148x40x32mm	5420061235398	€ 46.50
	6MWLPF_0400012	12V	3.34A	7.2-12V	163x43x32mm	5420061235404	€ 51.50
	6MWLPF_0600012	12V	5.00A	7.2-12V	163x43x32mm	5420061232892	€ 55.75
	6MWLPF_0250024	24V	1.05A	13.2-24V	148x40x32mm	5420061231772	€ 46.50
	6MWLPF_0400024	24V	1.67A	14.4-24V	163x43x32mm	5420061231789	€ 51.50
	6MWLPF_0600024	24V	2.50A	14.4-24V	163x43x32mm	5420061231796	€ 55.75
dimmable	6MWLPF_0900024	24V	3.75A	14.4-24V	161x61x36mm	5420061235411	€ 81.00
	6MWLPFD0250012	12V	2.1A	6.6-12V	148x40x32mm	5420061233028	€ 49.50
	6MWLPFD0400012	12V	3.34A	7.2-12V	163x43x32mm	5420061233431	€ 54.75
	6MWLPFD0600012	12V	5.00A	7.2-12V	163x43x32mm	5420061210289	€ 59.00
	6MWLPFD0250024	24V	1.05A	13.2-24V	148x40x32mm	5420061232977	€ 49.50
	6MWLPFD0400024	24V	1.67A	14.4-24V	163x43x32mm	5420061232762	€ 54.75
	6MWLPFD0600024	24V	2.50A	14.4-24V	163x43x32mm	5420061212993	€ 59.00
	6MWLPFD0900024	24V	3.75A	14.4-24V	161x61x36mm	5420061214737	€ 86.25

*BRUTO WITHOUT VAT/PIECE

Dimming standards: 10% -> 100%

Resistor : 10kOhm -> 100kOhm
 Voltage input : 1-10V
 10V PWM (100-3KHz) input

Available voltages:

{12},15,20,24,30,36,42,48,54V
 (replace the two last digits of reference with relevant voltage)

Protection

SC: Short Circuit
 OC: Over Current
 OV: Over Voltage
 OT: Over Temperature

WATERPROOF HIGH POWER PSU (CV)

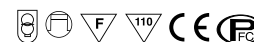

Property	Value
Input voltage	100w-150W: 90-305VAC / 127-430VDC 200w: 90-295VAC / 127-417VDC
Frequency	47-63Hz
IP Level	IP67
Mode	Constant Voltage
PFC	Yes
Protection	OVP / OCP / SCP / OTP
Warranty	2 years
Dimmable	No



Universal AC input / Full range (up to 305 VAC), built-in active PFC function
 Protections : Short circuit / Over current / Over voltage / Over temperature,
 cooling by free air convection.

IP67 design for indoor or outdoor installations.

References:

Model	Description				GTIN/EAN	Price*
	Output V	Output I	Power	Size (LxWxH)		
SPDCLG01000012	12V	8.3A	99.6W	199x68x39mm	5420061208705	€ 89.00
SPDCLG01000024	24V	4.2A	100.8W	199x68x39mm	5420061208712	€ 89.00
SPDCLG01500024	24V	6.3A	151.2W	199x68x39mm	5420061200440	€ 99.00
SPDCLG02000012	12V	13.4A	160.8W	221x68x39mm	5420061200433	€ 119.00
SPDCLG02000024	24V	8.3A	199.2W	221x68x39mm	5420061213686	€ 119.00

*BRUTO WITHOUT VAT/PIECE

Protection

SC: Short Circuit
 OC: Over Current
 OV: Over Voltage
 OT: Over Temperature

OUTDOOR LIGHTING WITH PFC

WATERPROOF MAINS DIMMABLE LED POWER SUPPLIES 12V, 24V (CV)



Property	Value
Input voltage	220-240VAC
Frequency	50-60Hz
IP Level	IP65
Mode	Constant Voltage
PFC	Yes
Protection	SC / OT
Warranty	2 years
Dimmable	Yes



Independent power supply with constant output voltage for LEDs, dimmable by leading and trailing edge dimmers.

We recommend the following products (non-binding; always test before use):
NIKO 31001300 - LEGRAND CELIANE 670184 - NIKO 33000700

The load must not fall below the minimum load of the dimmer.

With lower LED load the dimming range is smaller.

Only connect LEDs in parallel! Do not insert switches into the secondary circuit!

References:

Model	Description			GTIN/EAN	Price*
	Output V	Power	Size (LxWxH)		
800594	12	36-60W	210x71x46mm	5420061235749	€ 81.00
800596	12	48-80W	210x71x46mm	5420061235763	€ 99.00
800595	24	36-60W	210x71x46mm	5420061235756	€ 81.00
800597	24	48-80W	210x71x46mm	5420061235770	€ 99.00

*BRUTO WITHOUT VAT/PIECE

Protection

SC: Short Circuit
OC: Over Current
OV: Over Voltage
OT: Over Temperature

OUTDOOR LIGHTING WITH PFC

WATERPROOF HIGH POWER PSU (CV+CC)



Property

Input voltage

Frequency

IP Level

Mode

PFC

Protection

Warranty

Value

90-305VAC / 127-431VDC

50-60Hz

IP67 (H and B series)

Constant Voltage with Constant Current Region

Yes

SC / OC / OV / OT

5 years



References:

	Model	Description				GTIN/EAN	Price*	
		Output V	Output I	Power	CC Region			Size (LxWxH)
Non dimmable	6MWHLGH1500012	12V	12.5A	150W	6-12V	228x68x38.8mm	5420061235480	€ 120.00
	6MWHLGH2400012	12V	16A	192W	6-12V	244.2x68x38.8mm	5420061206701	€ 152.00
	6MWHLGH3200012	12V	22A	264W	6-12V	252x90x43.8mm	5420061216687	€ 220.00
	6MWHLGH6000012	12V	40A	480W	6-12V	280x144x48.5mm	5420061235466	€ 360.00
	6MWHLGH1500024	24V	6.3A	151.2W	12-24V	228x68x38.8mm	5420061235497	€ 120.00
	6MWHLGH2400024	24V	10A	240W	12-24V	244.2x68x38.8mm	5420061206701	€ 152.00
	6MWHLGH3200024	24V	13.34	320.16W	12-24V	252x90x43.8mm	5420061216687	€ 220.00
	6MWHLGH6000024	24V	25A	600W	12-24V	280x144x48.5mm	5420061235473	€ 360.00
dimmable	6MWHLGB1500012	12V	12.5A	150W	6-12V	228x68x38.8mm	5420061214706	€ 126.00
	6MWHLGB2400012	12V	16A	192W	6-12V	244.2x68x38.8mm	5420061231635	€ 158.00
	6MWHLGB3200012	12V	22A	264W	6-12V	252x90x43.8mm	5420061214683	€ 220.00
	6MWHLGB6000012	12V	40A	480W	6-12V	280x144x48.5mm	5420061235459	€ 360.00
	6MWHLGB1500024	24V	6.3A	151.2W	12-24V	228x68x38.8mm	5420061214690	€ 126.00
	6MWHLGB2400024	24V	10A	240W	12-24V	244.2x68x38.8mm	5420061221582	€ 158.00
	6MWHLGB3200024	24V	13.34	320.16W	12-24V	252x90x43.8mm	5420061216687	€ 220.00
	6MWHLGB6000024	24V	25A	600W	12-24V	280x144x48.5mm	5420061235442	€ 360.00

*BRUTO WITHOUT VAT/PIECE

Dimming standards: 10% -> 100%

Resistor : 10kOhm -> 100kOhm
Voltage input : 1-10V
10V PWM (100-3KHz) input

Available voltages:

12,15,20,24,30,36,42,48,54V
(replace the two last digits
of reference with relevant voltage)

Protection

SC: Short Circuit
OC: Over Current
OV: Over Voltage
OT: Over Temperature

DIN RAIL

DIN RAIL POWER SUPPLIES 30 → 100 W (CV) DIN RAIL LED POWER SUPPLIES 120 → 960 W (CV)



Features

30 → 100 W

Universal AC input / Full range
 Protections : OC / OL / OV / OT
 Cooling by free air convection
 Can be installed on DIN rail TS-35/7.5 or 15
 Isolation class II
 LED indicator for power on
 100% full load burn-in test
 3 years warranty

120 → 960 W

AC input range selectable by switch
 Protections : Short circuit / Overload /
 Over voltage / Over temperature
 Cooling by free air convection
 Can be installed on DIN rail TS-35/7.5 or 15
 UL 508 (industrial control equipment) approved
 LED indicator for power on
 100% full load burn-in test
 Fixed switching frequency at 55KHz



References:

	Model	Description				GTIN/EAN	Price*	
		Output V	Output I	Power	Size (LxWxH)			
Modular - Non PFC	6MWDR0150012	12V	1.25A	15W	93x56x25mm	5420061210029	€ 24.30	
	6MWDR0150024	24V	0.63A	15.2W	93x56x25mm	5420061210364	€ 24.30	
	6MWDR0300012	12V	2A	24W	93x78x56mm	5420061201058	€ 30.00	
	6MWDR0300024	24V	1.5A	36W	93x78x56mm	5420061201041	€ 30.00	
	6MWDR0600012	12V	4.5A	54W	93x78x56mm	5420061201669	€ 41.00	
	6MWDR0600024	24V	2.5A	60W	93x78x56mm	5420061201676	€ 41.00	
	6MWDR1000012	12V	7.5A	90W	100x93x56mm	5420061204134	€ 59.00	
	6MWDR1000024	24V	4.2A	97.5W	100x93x56mm	5420061204141	€ 59.00	
	Non modular with PFC	6MWDR1200012	12V	10A	120W	125.2x100x65.5mm	5420061204424	€ 72.00
		6MWDR1200024	24V	5A	120W	125.2x100x65.5mm	5420061204417	€ 72.00
6MWDRP2400024		24V	10A	240W	125.5x125.2x100mm	5420061206206	€ 112.00	
6MWDRP4800024		24V	5A	240W	125.5x125.2x100mm	5420061210463	€ 199.00	

*BRUTO WITHOUT VAT/PIECE

Protection

SC: Short Circuit
 OL: Over Load
 OV: Over Voltage
 OT: Over Temperature

Constant current Power Supplies



LOW POWER LIGHTING PSU (CC)

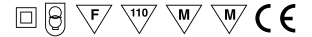

Property

- Input voltage
- Frequency
- IP Level
- Mode
- PFC
- Protection
- Warranty

Value

- 100V-240VAC
- 50-60Hz
- Depending on model
- Constant Voltage
- Depending on model
- SC / OC / OV / OT
- 2 years



References:

Model	Description								GTIN/EAN	Price*
	Input	V out Max	Operating V	Output I	Power	PF	IP	Size (LxWxH)		
I401327	100-240V	17	3-12	350mA	3W	0.4	66	38x27x21.5mm	5420061219664	€ 9.50
I401330	100-240V	14	3-9.5	500mA	3W	0.4	66	38x27x21.5mm	5420061235527	€ 9.50
I401331	100-240V	9.5	3-6	700mA	3W	0.4	66	38x27x21.5mm	5420061219671	€ 9.50
I401243	220-240V	24	3-12	350mA	6W	0.6	20	49x41x21mm	5420061215383	€ 10.90
I401244	220-240V	12	3-8.5	700mA	6W	0.6	20	49x41x21mm	5420061215390	€ 10.90
I401235	220-240V	24	3-21	350mA	8W	0.6	20	58x35x21mm	5420061215369	€ 11.65
I401236	220-240V	12	3-8.5	700mA	8W	0.6	20	58x35x21mm	5420061215376	€ 11.65
I401293	220-240V	46	20-43	350mA	15W	0.5	20	128x51x14mm	5420061215505	€ 15.15
I401294	220-240V	24	11-21	700mA	15W	0.5	20	128x51x14mm	5420061215512	€ 15.15

*BRUTO WITHOUT VAT/PIECE

For special requirements please contact us

Protection

- SC: Short Circuit
- OC: Over Current
- OV: Over Voltage
- OT: Over Temperature





Aluminum
Profiles



Aluminum Profiles

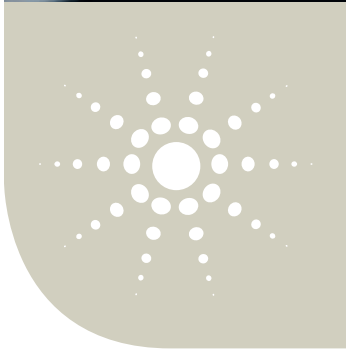
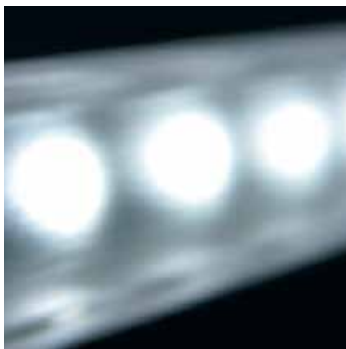

ALUMINUM LED PROFILE 1504

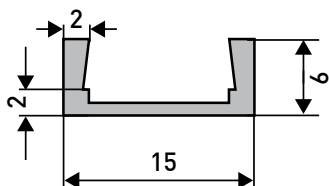
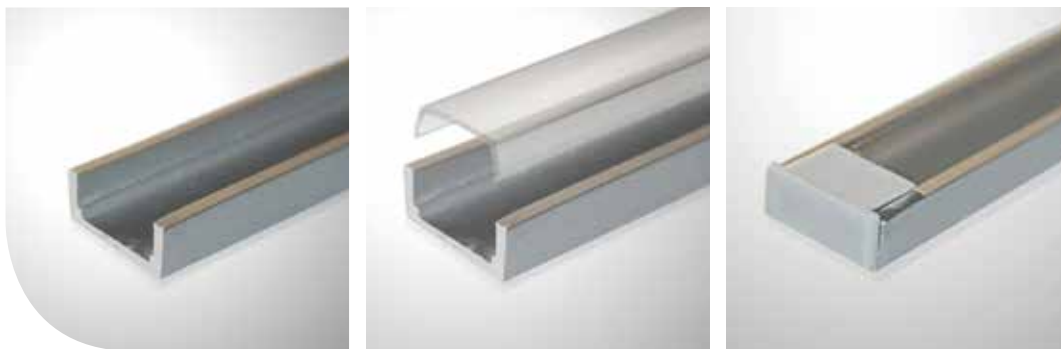

Features:

- › Anodized aluminium finish
- › Designed and produced in Europe
- › Convenient for all low power LED strips
- › Maximum strip width 10mm

Accessories:



References:

Model	Description	Price*
ZALUPRO1504X2M	Anodized Aluminum LED profile, 15x4mmx2m	€ 22.00
ZTRACOV1504X2M	Plastic Cover, 2m, Transparent	€ 22.00
ZENDCAPCOH1504	PVC End Cap with hole	€ 5.00
ZENDCAPCOV1504	PVC End Cap without hole	€ 5.00
ZALUPROCLIP1504	Fixing clip	€ 5.00

*BRUTO WITHOUT VAT/PIECE

ALUMINUM LED PROFILE 1911

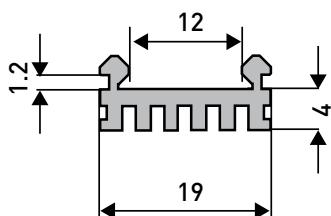

Features:

- › Maximum strip width: 12.2mm
- › External dimensions: 19x11mmx2m
- › Convenient for high power LED strips

Accessories:



References:

Model	Description	Price*
IALUPRO1911X2M	Anodized Aluminum LED profile, 19x11mmx2m	€ 22.00
ITRACOV1911X2M	Transparent cover, 2m	€ 9.00
ITRACOF1911X2M	Frosted cover, 2m	€ 9.00
IENDCAPCOH1911	End cap with hole	€ 1.50
IENDCAPCOV1911	End cap without hole	€ 1.50
IALPROCLIP1911	Fixing Metal clip	€ 0.50

*BRUTO WITHOUT VAT/PIECES

ALUMINUM LED PROFILE 1808

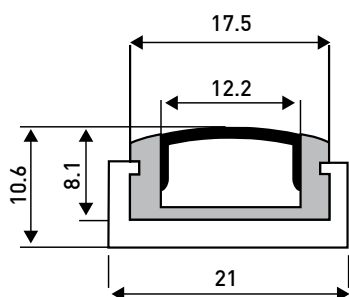

Features:

- › Anodized cost efficient aluminum profile for low and medium power LED strips (up to 10W/m) with a maximum width of 12mm
- › Individual plastic sleeve for scratch protection
- › Metal and Plastic Clips available
- › Transparent and Frosted Covers available

Accessories :



References:

Model	Description	Price*
ZALUPRO1808X2M	Anodized Aluminum LED Profile, 18x8mmx2m	€ 12.00
ZTRACOV1808X2M	Transparent cover, 2m	€ 9.00
ZTRACOF1808X2M	Frosted cover, 2m	€ 9.00
ZENDCAPCOH1808	Plastic end cap with hole	€ 1.50
ZENDCAPCOV1808	Plastic end cap without hole	€ 1.50
ZALPRMCLIP1808	Fastening Metal clip	€ 1.00
ZCORNERCON1808	SpotLED 90° corner accessory for 1808 profile	€ 5.90

*BRUTO WITHOUT VAT/PIECE

ALUMINUM RECESSED LED PROFILE 2508

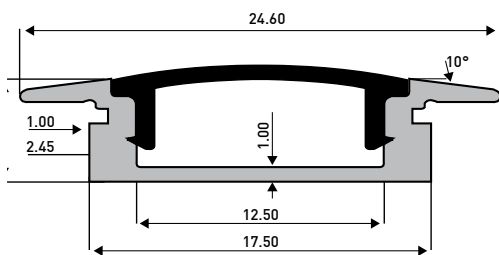

Features:

- › Recessed type with clean design
- › Very low profile
- › Perfect for low power LED strips
- › Cover placed/removed from the top
- › Available with frosted or transparent cover
- › Anodized finish aluminium
- › Individual plastic sleeve for scratch protection

Applications:

- › Kitchen cabinets LED lighting
- › Furniture production
- › Interior accent lighting
- › Shop shelf lighting

Accessories:

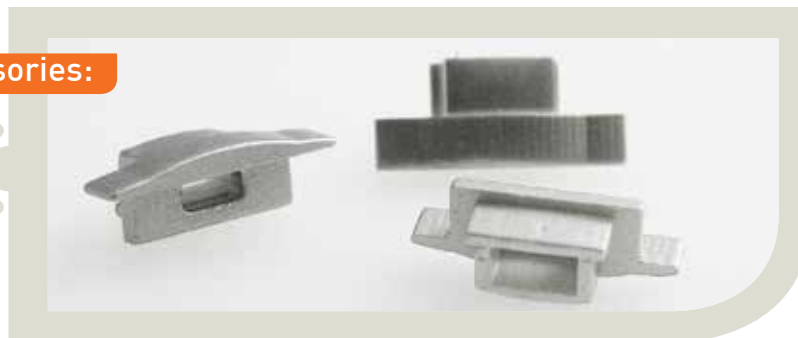

References:

Model	Description	Price*
ZALUPRO2508X2M	Anodized aluminum recessed LED profile, 25x8mmx2m	€ 12.90
ZTRACOV1808X2M	Transparent cover, 2m	€ 9.00
ZTRACOF1808X2M	Frosted cover, 2m	€ 9.00
ZENDCAPCOH2508	Plastic end cap with hole	€ 1.50
ZENDCAPCOV2508	Plastic end cap without hole	€ 1.50

*BRUTO WITHOUT VAT/PIECES

ALUMINUM LED PROFILE 1812

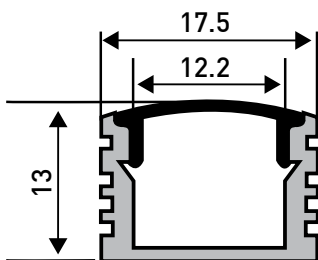

Features:

- › High quality cover, placing/removing from the front
- › Led dots free profile (frosted)
- › Available with frosted and transparent cover
- › Anodized aluminum finish
- › Suitable for low/high power LED bars
- › For indoor use only
- › Individual plastic sleeve for scratch protection

Applications:

- › Furniture production (kitchen / office)
- › Interior light design (stairs / storage / floor)
- › Stores shelf LED lighting
- › Independent LED lamp
- › Exhibition booth LED lighting

Accessories:



References:

Model	Description	Price*
ZALUPR01812X2M	Anodized aluminum LED profile 18x12mmx2m	€ 14.50
ZTRACOV1808X2M	Transparent cover, 2m	€ 9.00
ZTRACOF1808X2M	Frosted cover, 2m	€ 9.00
ZENDCAPCOH1812	Plastic end cap with hole	€ 1.50
ZENDCAPCOV1812	Plastic end cap without hole	€ 1.50
ZALPRMCLIP1812	Fastening Metal clip for 1812 profile	€ 1.00

*BRUTO WITHOUT VAT/PIECE

ALUMINUM LED RECESSED PROFILE 2515

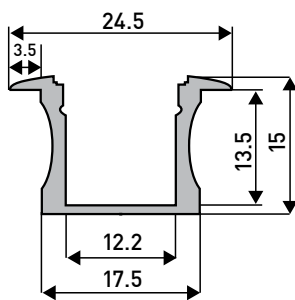

Features:

- › Anodized aluminum finish
- › High Quality UV resistant polycarbonate snap in cover
- › Choice of frosted or transparent cover
- › Reduced light loss design
- › Small dimensions only 15mm high
- › Suitable for standard LED strips up to 12mm of wide
- › Available with dedicated finish end caps

Applications:

- › Recessed LED lighting under kitchen cabinets
- › Storage shelves LED lighting
- › Furniture production
- › Exhibition booth LED lighting

Accessories:

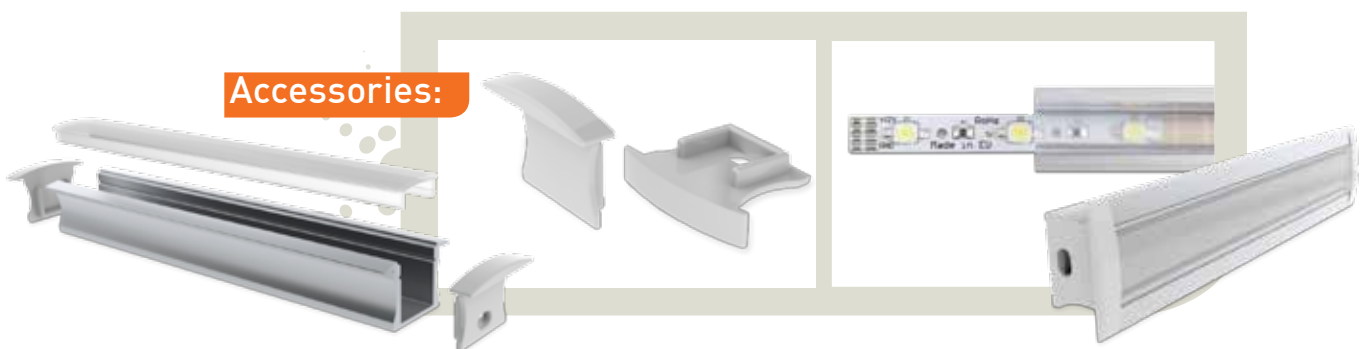

Especially designed for true line effect (no dot), to be used with 60 and 120LED/m LED Strips

References :

Model	Description	Price*
ZALUPRO2515X2M	Anodized Aluminum Recessed LED profile, 25x15mmx2m	€ 39.90
ZTRACOV17__X2M	Polycarbonate Cover, Clip on system, 2m, Transparent	€ 3.90
ZTRACOF17__X2M	Polycarbonate Cover, Clip on system, 2m, Frosted	€ 3.90
ZENDCAPCOH2515	PVC End Cap with hole	€ 3.90
ZENDCAPCOV2515	PVC End Cap without hole	€ 3.90

ALUMINUM WIDE LED PROFILE 2208

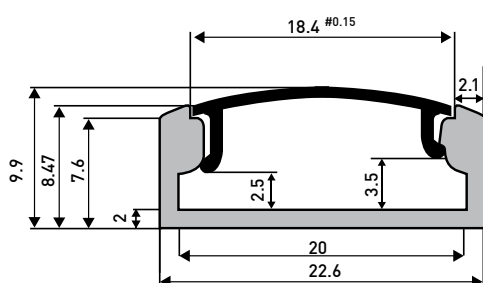

Features:

- › Anodized aluminum finish
- › High Quality UV resistant polycarbonate snap on cover
- › Two different light covers to chose from, frosted or transparent
- › Reduced light loss design
- › Small dimensions only 8mm high
- › Extra space inside the profile (20mm) for IP67 LED strips, RGB or double row LED strips
- › Available with dedicated accessories such as end caps and mounting brackets

Applications :

- › Led lamps
- › Retail store shelves LED lighting
- › Kitchen cabinets LED lighting
- › Exhibitions, hotels, restaurants LED lighting
- › Interior design

Accessories:

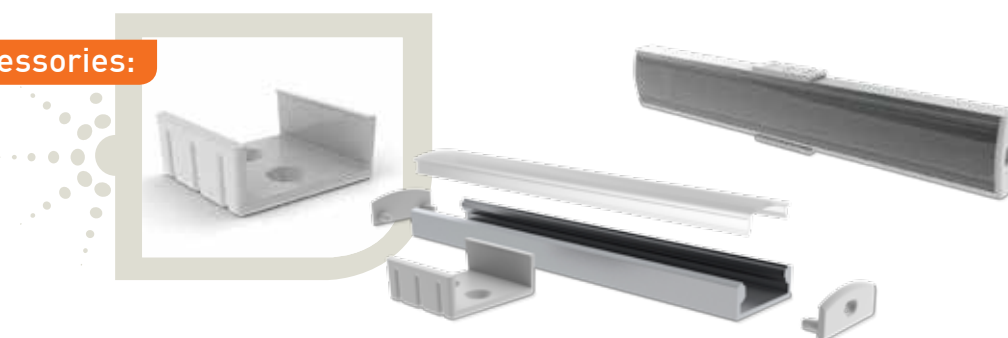

References:

Model	Description	Price*
ZALUPRO2208X2M	Anodized Aluminum LED profile, 22x8mmx2m	€ 64.90
ZTRACOV22__X2M	Polycarbonate Cover, Clip on system, 2m, Transparent	€ 3.90
ZTRACOF22__X2M	Polycarbonate Cover, Clip on system, 2m, Frosted	€ 3.90
ZENDCAPCOH2208	PVC End Cap with hole	€ 3.90
ZENDCAPCOV2208	PVC End Cap without hole	€ 3.90
ZALPROCLIP2208	PVC Grey Clip	€ 3.90

ALUMINUM WIDE LED PROFILE 2215

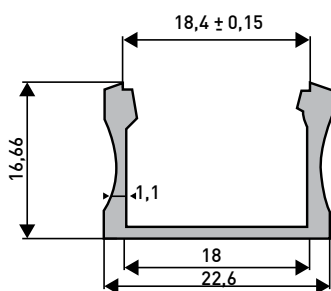

Features:

- › Anodized aluminum finish
- › High Quality UV resistant polycarbonate snap on cover
- › Two different light covers to choose from :
frosted (LEDs dots free) and transparent
- › Extra space inside the profile (18mm) for IP67 LED strips, RGB or double row LED strips
- › Suitable for high power LED strips up to 30W/m
- › Available with dedicated finish end caps and mounting bracket

Applications:

- › Led lamps
- › Shelf LED lighting for retail store
- › Cabinets LED lighting for kitchen
- › Interior design

Accessories:

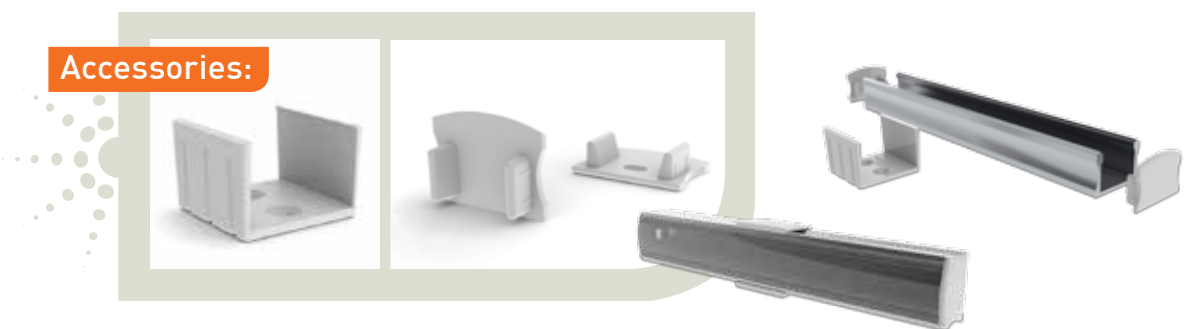

References:

Model	Description	Price*
ZALUPRO2215X2M	Anodized Aluminum LED profile, 22x17mmx2m	€ 64.90
ZTRACOV22__X2M	Polycarbonate Cover, Clip on system, 2m, Transparent	€ 3.90
ZTRACOF22__X2M	Polycarbonate Cover, Clip on system, 2m, Frosted	€ 3.90
ZENDCAPCOH2215	PVC End Cap with hole	€ 3.90
ZENDCAPCOV2215	PVC End Cap without hole	€ 3.90
ZALPROCLIP2215	PVC Grey Clip	€ 3.90

*BRUTO WITHOUT VAT/PIECES

ALUMINUM LED PROFILE 3535

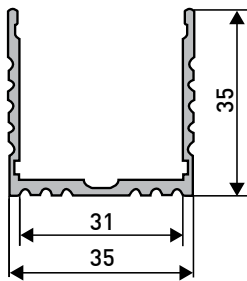

Features:

- › High Quality UV resistant polycarbonate snap on cover
- › Two different light covers to choose from, frosted (LEDs dots free) and transparent
- › Contemporary design
- › Suitable for standard or high power LED stripes up to 30W/m
- › Available with dedicated accessories such as two type of end caps
- › Anodized aluminum finish

Applications:

- › LED lamp component
- › Retail store main ceiling LED lighting
- › Suspended LED lighting lamp
- › Exhibitions, hotels, restaurants main LED lighting
- › Decorative linear LED lighting
- › Exhibition booth LED lighting



References:

Model	Description	Price*
ZALUPRO3535X2M	Anodized Aluminum LED profile, 35x35mm x2m	€ 109.90
ZTRACOV35__X2M	Polycarbonate Cover, Clip on system, 2m, Transparent	€ 9.90
ZTRACOF35__X2M	Polycarbonate Cover, Clip on system, 2m, Frosted	€ 9.90
ZENDCAPC003535	End cap with ears	€ 6.90
ZENDCAPCOV3535	End cap without ears	€ 6.90

ALUMINUM RECESSED LED PROFILE 4435

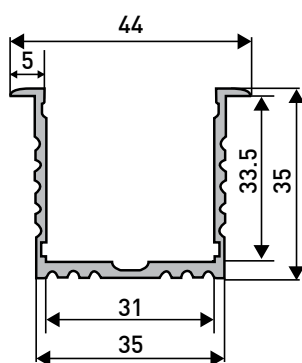

Features:

- › High quality polycarbonate cover
- › No LED dots shows on the diffuser cover surface
- › Soft and smooth light diffusion
- › Cover is placed/removed from the top on click
- › Anodized aluminum finish
- › Heavy duty "heat sink" for high power LEDs
- › Matching end caps for this profile are available
- › Gypsum ceiling installation
- › Available in length of 2m with clear or frosted cover

Applications:

- › Show rooms ceiling LED lighting
- › Restaurants ceiling LED lighting
- › Shopping malls LED lighting

Accessories:

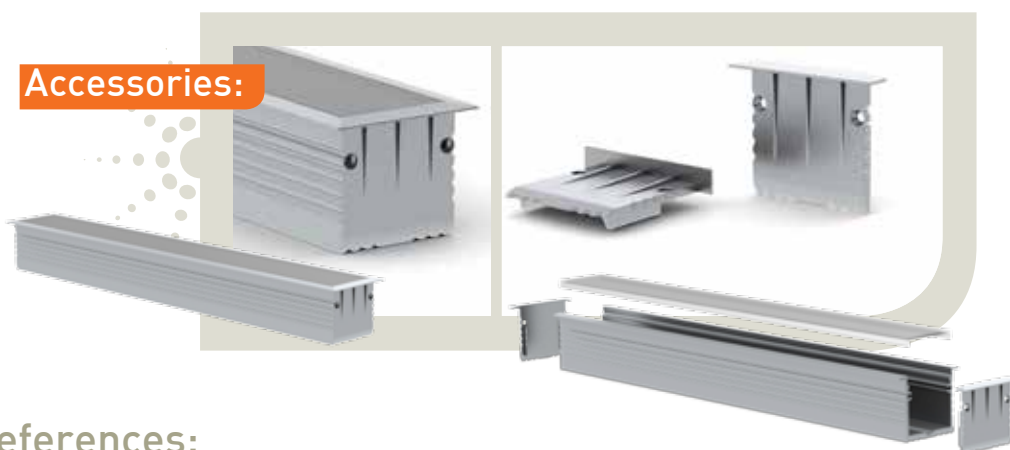

References:

Model	Description	Price*
ZALUPRO4435X2M	Anodized Aluminum LED profile, 44x35mmx2m	€ 109,90
ZTRACOV35__X2M	Polycarbonate Cover, Clip on system, 2m, Transparent	€ 6,90
ZTRACOF35__X2M	Polycarbonate Cover, Clip on system, 2m, Frosted	€ 6,90
ZENDCAPC004435	End Cap with ears	€ 6,90
ZENDCAPCOV4435	End Cap without ears	€ 6,90

ALUMINUM ROUND LED PROFILE RD25

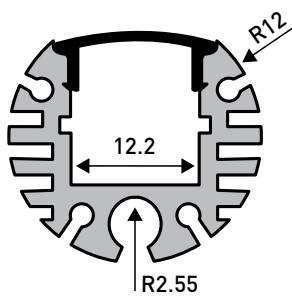

Features:

- › High quality round shape polycarbonate cover
- › Cover is placed/removed from the top on click
- › Anodized aluminum finish
- › Heavy duty "heat sink" for high power LEDs
- › Compatible with up to 12mm wide high power LED bars
- › Available finish end caps and mounting system with angle adjustment
- › Available in length of 2m with transparent or frosted cover

Applications:

- › Show rooms lighting
- › Reception desk main lighting
- › Restaurants table lighting
- › Shopping boutiques exposition lighting

Accessories:



References:

Model	Description	Price*
ZALUPRORD25X2M	Anodized aluminum round LED profile, 24mm diameter x 2m	€ 27.60
ZTRACOV1808X2M	Transparent cover, 2m	€ 9.00
ZTRACOF1808X2M	Frosted cover, 2m	€ 9.00
ZENDCAPCOHRD25	End cap with hole for RD25 profile	€ 2.20
ZENDCAPCOVRD25	End cap without hole for RD25 profile	€ 2.20
ZALPROVERFRD25	Vertical foot for RD25 profile	€ 5.80

*BRUTO WITHOUT VAT/PIECES

ALUMINUM STAIR STEP NOSE LED PROFILE SR66

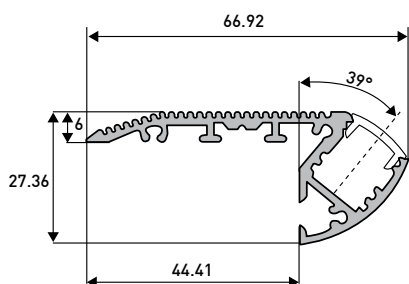

Features:

- › Hard aluminum alloy and special anodizing thickness
- › High standard of anodizing aluminum
- › High Quality UV resistant polycarbonate snap on cover (LEDs dots free) and transparent
- › Stair installed LED profile with smooth line of light
- › Suitable for standard or high power LED strips up to 30W/m
- › Possible isolation of the cover and end cap against water with transparent silicone
- › Available with dedicated end caps

Applications:

- › Stair LED lighting illumination
- › Hotels, cinemas, restaurants, night clubs, stair LED lighting

Accessories:

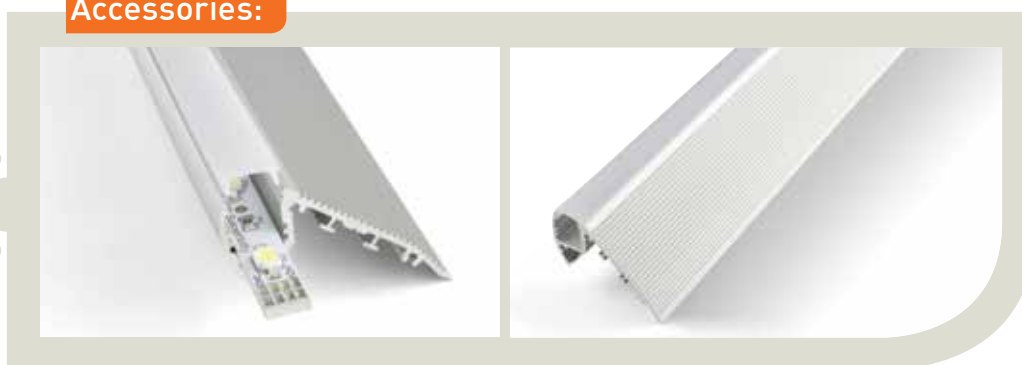

References:

Model	Description	Price*
ZALUPROSR66X2M	Anodized aluminum LED Profile for stair step nose, 2m	€ 119.90
ZTRACOV17__X2M	Transparent Polycarbonate Cover, 2m	€ 3.90
ZTRACOF17__X2M	Frosted Polycarbonate Cover 2m	€ 3.90
ZENDCAPCOLSR66	PVC end cap for sr66/left	€ 7.70
ZENDCAPCORSR66	PVC end cap for sr66/right	€ 7.70

*BRUTO WITHOUT VAT/PIECES

ALUMINUM WALL RECESSED LED PROFILE WL70

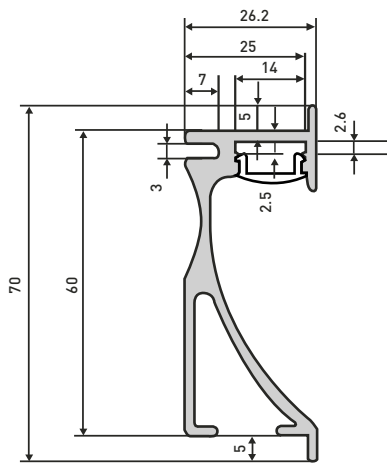
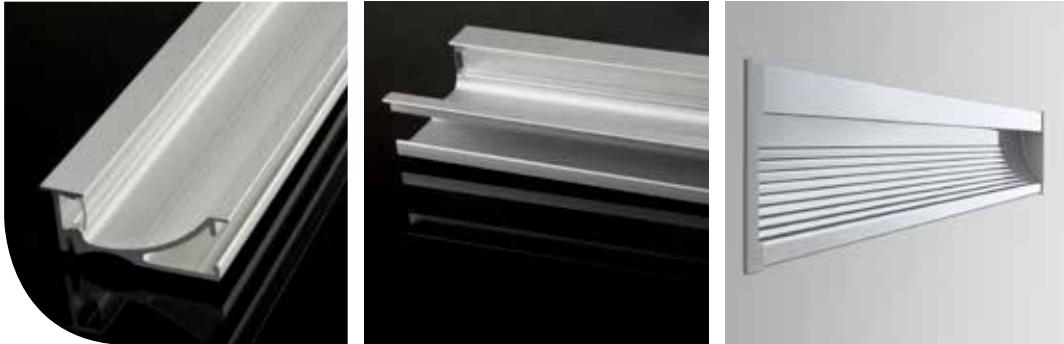

Features:

- › Asymmetric, wall installed LED profile for floor LED lighting
- › High standard of anodizing aluminum surface
- › High Quality UV resistant polycarbonate snap on cover
- › Two different light covers to choose from : frosted or transparent
- › Extra LED heat sink capability of the profile (up to 30W/m)
- › Available with dedicated finish end caps
- › Indoor and outdoor use (outdoor with IP67 leds)

Applications:

- › Asymmetric, wall build-in type
- › Floor hallways LED lighting profile
- › Perfect for hotels hallways, restaurant, hospitals, underground
- › Walkways LED lighting

Accessories :

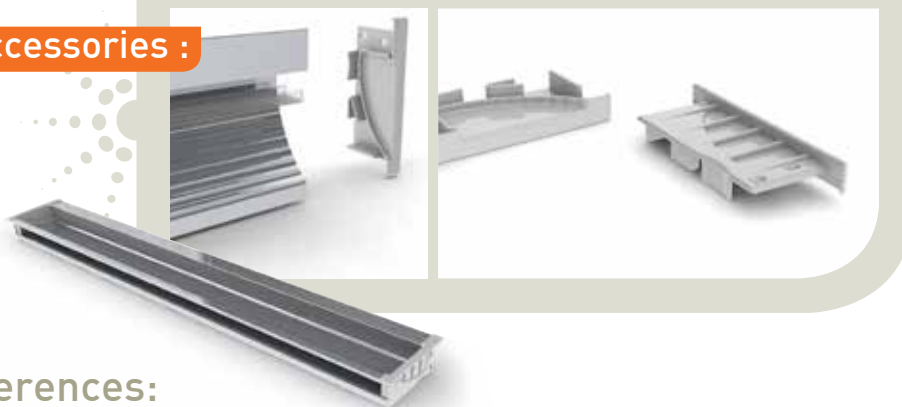

References:

Model	Description	Price*
ZALUPROWL70X2M	Anodized aluminum LED profile (wall recessed) 2m	€ 104.90
ZTRACOV17__X2M	Transparent LED Cover 2m	€ 3.90
ZTRACOF17__X2M	Frosted LED Cover 2m	€ 3.90
ZENDCAPCOLWL70	PVC End Cap Grey Left	€ 7.70
ZENDCAPCORWL70	PVC End Cap Grey Right	€ 7.70

*BRUTO WITHOUT VAT/PIECES

ALUMINUM 45° CORNER LED PROFILE XL45

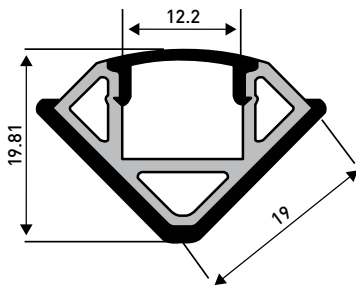
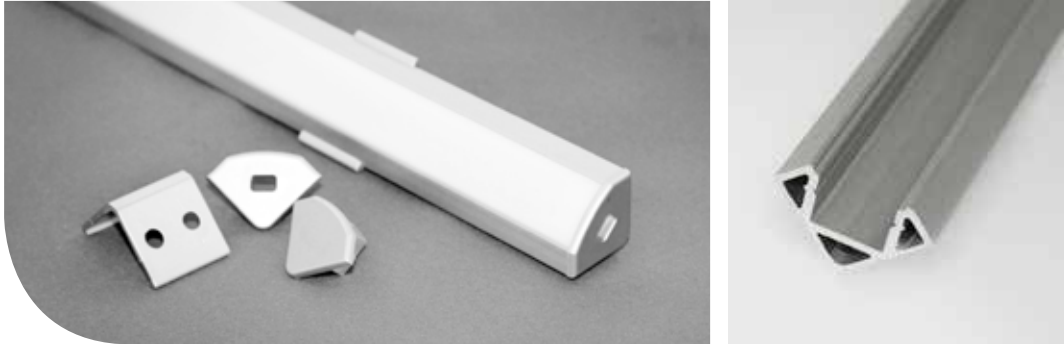

Features:

- › High quality cover now placing from the front on click
- › Cover available in transparent, and frosted
- › Base of the profile is made in anodized aluminum
- › Suitable for low power and high power LEDS
- › Simplicity design with high quality finish
- › Individual plastic sleeve for scratch protection

Applications:

- › Under kitchen cabinets LED lighting
- › Stores shelves LED lighting
- › Furniture production, inside cabinets LED lighting
- › Storage shelves LED lighting
- › Exhibition booth LED lighting

References:

Model	Description	Price*
ZALUPROXL45X2M	Anodized aluminum LED profile 45°, 19.5x27mmx2m	€ 23.50
ZTRACOV1808X2M	Transparent cover, 2m	€ 9.00
ZTRACOF1808X2M	Frosted cover, 2m	€ 9.00
ZENCAPCOHXL45	Plastic end cap with hole	€ 1.50
ZENCAPCOVXL45	Plastic end cap without hole	€ 1.50
ZALPRMCLIPXL45	Metal clip	€ 1.00

*BRUTO WITHOUT VAT/PIECES

ALUMINUM RECESSED LED PROFILE 3315

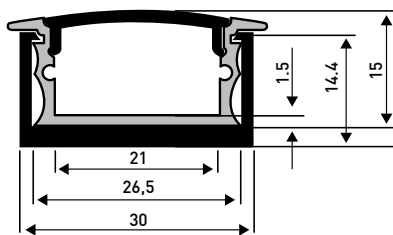

Features:

- › Recessed type with clean design
- › Very low profile
- › Perfect for low power LED strips
- › Cover slided from the side
- › Available with frosted or transparent cover
- › Anodized aluminum finish

Applications:

- › Kitchen cabinets LED lighting
- › Furniture production
- › Interior accent lighting
- › Shop shelf lighting
- › For wide LED strips and waterproof LED strips

Accessories:



References:

Model	Description	Price*
ZALUPRO3315X2M	Anodized aluminum recessed LED profile, 33x15mmx2m	€ 17.40
ZTRACOV3315X2M	Transparent cover for LED profile, 2m	€ 14.80
ZTRACOF3315X2M	Frosted cover for LED Profile, 2m	€ 14.80
ZENDCAPCOH3315	End cap with hole for 3315 profile	€ 1.50
ZENDCAPCOV3315	End cap without hole for 3315 profile	€ 1.50

*BRUTO WITHOUT VAT/PIECES

ALUMINUM ADJUSTABLE LED PROFILE AD20

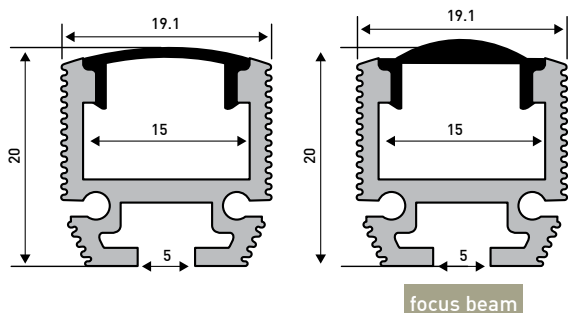
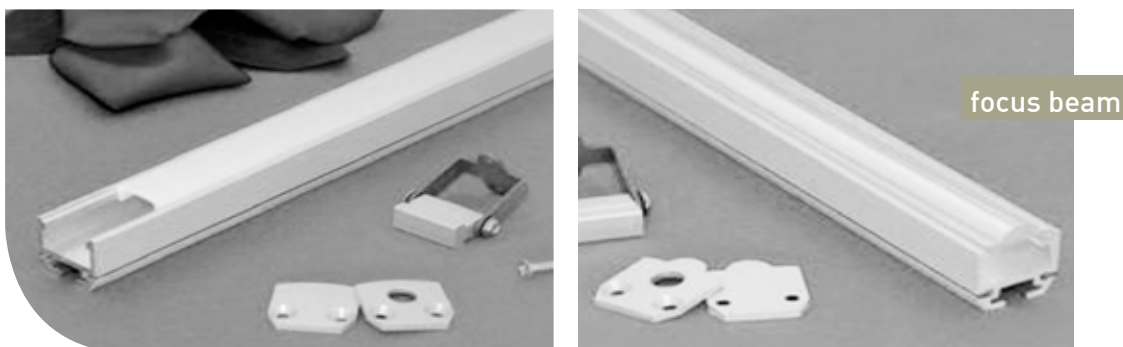

Features:

- › High quality cover placed from the front on click
- › Cover available in transparent and frosted
- › Base of the profile is made in anodized aluminum
- › Suitable for low power and high power LEDs
- › Simplicity in design with high quality finish
- › Individual plastic sleeve for scratch protection

Applications:

- › Under kitchen cabinets LED lighting
- › Stores shelves LED lighting
- › Floor LED lighting
- › Storage shelves LED lighting
- › Exhibition booth LED lighting
- › Interior LED lighting

Accessories

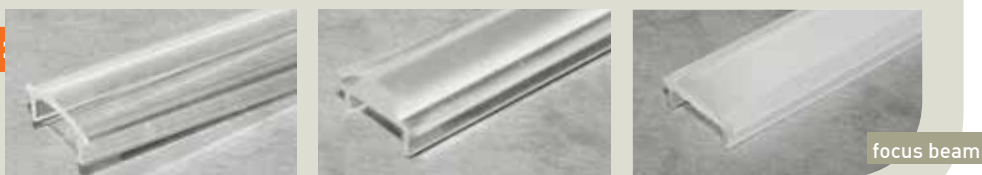

References :

Model	Description	Price*
ZALUPROAD20X2M	Anodized aluminum adjustable LED profile, 19x20mmx2m	€ 26.70
ZTRACOV1808X2M	Transparent cover, 2m	€ 9.00
ZTRACOF1808X2M	Frosted cover, 2m	€ 9.00
ZTRACFV1808X2M	Focus beam transparent cover	€ 29.90
ZTRACFF1808X2M	Focus beam frosted cover	€ 29.90
ZALPROORFTAD20	Orientable holder	€ 6.80
ZENDCAPCOHAD20	End cap with hole (std cover)	€ 2.00
ZENDCAPCOVAD20	End cap without hole (std cover)	€ 2.00
ZENDCAPCFHAD20	End cap with hole (focus cover)	€ 2.00
ZENDCAPCFVAD20	End cap without hole (focus cover)	€ 2.00

*BRUTO WITHOUT VAT/PIECES

ALUMINUM H-SHAPED LED PROFILE 3018

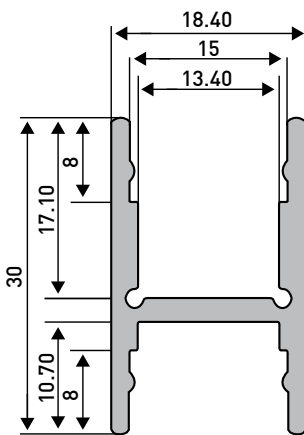

Features :

- › Anodized aluminum finished
- › Included integrated cable duct
- › Available with transparent cover

Applications :

- › For mounting in walls, floor and ceiling
- › Also usable as pendant light and for two sided application of LED strips (be aware of thermal management)

Accessories :



References :

Model	Description	Price*
ZALUPRO3018X2M	Anodized aluminum recessed LED profile, 30x18mmx2m	€ 31.90
ZTRACOV3018X2M	Transparent Cover, 2m	€ 16.90
ZTRACOF3018X2M	Frosted Cover, 2m	€ 16.90
ZENDCAPSET3018	End Cap Set	€ 15.90
ZALUPRC3018X2M	Clip On Profile	€ 10.10
ZALPRMCLIP3018	Fastening Clip	€ 7.90
ZALWHANGINGKIT	Hanging Kit With 2X 150cm wire cable & accessories	€ 59.90

*BRUTO WITHOUT VAT/PIECES





Decoration



MINI GROUND SPOT 40MM

Property	Value
Head diametre	40mm
Hole diametre	32mm
Height	45mm
Beam angle	120°
LED	Nichia (white)
Cover	Frosted
Input	350mA
Power	1W-350mA 1.5W-500mA
Mode	Constant current
IP level	IP68

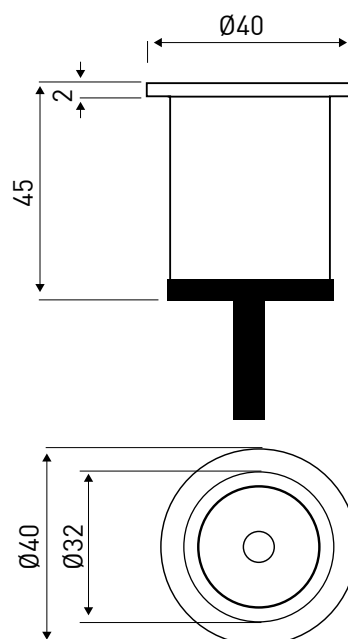

References:

Model	Description	GTIN/ EAN	Price*
SN001GDCI12027	Warm White 2700K	5420061235428	€ 78.00
SN001GDCI12040	Neutral White 4000K	5420061235435	€ 78.00

*BRUTO WITHOUT VAT/PIECE

HIGH POWER GROUND SPOT 110MM



High performance IP67 ground light designed by Conception Luminance with double layer coating for high resistance to corrosion: chemical conversion coating on the aluminium surface followed by a first layer of epoxy powder and a second finishing layer of polyester.

Tempered transparent (sandblasted glass on request), moulded silicone gasket, aluminium or AISI 316L stainless steel frame.

Installation

The luminaire is equipped with M16x1.5 plastic cable gland and a piece of cable for an easy-to-make connection. Outdoor use requires suitable flexible cables assuring the watertightness of the cable gland. Installation requires a dedicated box to be ordered separately.

It is important to provide a 300mm gravel layer or a drain system (for concrete surface) to ensure good drainage and to avoid water stagnation.

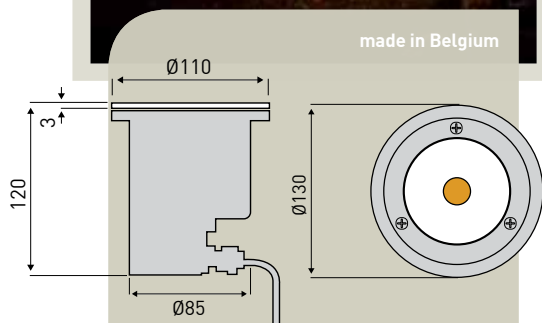

References:

Model	Description	GTIN/ EAN	Prices*
SZ013GDSI01830	Citizen LED CRI 80 48VDC 13W 18° 3000K	5420061232502	€ 349.00
SZ013GDSI07530	Citizen LED CRI 80 48VDC 13W 75° 3000K	5420061232519	€ 349.00
SZ013GDSI01850	Citizen LED CRI 80 48VDC 13W 18° 5000K	5420061232526	€ 349.00
SZ013GDSI07550	Citizen LED CRI 80 48VDC 13W 75° 5000K	5420061232533	€ 349.00
SZ018GDSI01830	Citizen LED CRI 80 48VDC 18W 18° 3000K	5420061232540	€ 349.00
SZ018GDSI07530	Citizen LED CRI 80 48VDC 18W 75° 3000K	5420061232557	€ 349.00
SZ018GDSI01850	Citizen LED CRI 80 48VDC 18W 18° 5000K	5420061232564	€ 349.00
SZ018GDSI07550	Citizen LED CRI 80 48VDC 18W 75° 5000K	5420061232571	€ 349.00
SGDLIGHTBOX110	Installation Box	5420061232632	€ 12.00

*BRUTO WITHOUT VAT/PIECE

MODEL OPTIONS

- CCT: 2700K, 3000K, 3500K, 4000K, 5000K
- IRC: 80 standard, 90 on request
- Dimmable version available on request

CUBIC LED WALL DOWNLIGHT

Property	Value
Input	350mA
Power	1W / 2x1W
Mode	Constant Current
IP Level	IP65
LED	CREE
Material	Aluminum
Hole diametre	20mm

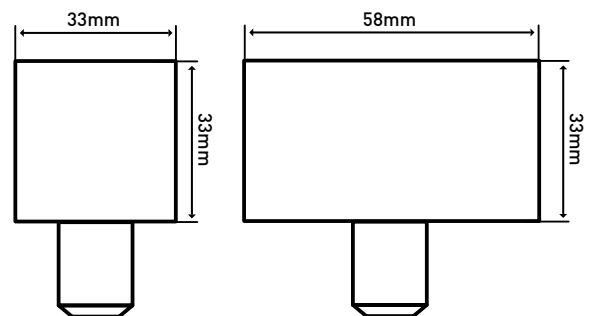

References:

Model	Description	GTIN/ EAN	Price*
YCC01WDCA02030	1W Warm White 20°	5420061200327	€ 34.00
YCC01WDCA02060	1W Cool White 20°	5420061207630	€ 34.00
YCC01WDCA06030	1W Warm White 60°	5420061200310	€ 34.00
YCC01WDCA06060	1W Cool White 60°	5420061207616	€ 34.00
YCC02WDCA02030	2W Warm White 20°	5420061202307	€ 49.00
YCC02WDCA02060	2W Cool White 20°	5420061202024	€ 49.00
YCC02WDCA06030	2W Warm White 60°	5420061202314	€ 49.00
YCC02WDCA06060	2W Cool White 60°	5420061201942	€ 49.00

*BRUTO WITHOUT VAT/PIECE

Other colors available on request : Amber, Red, Green, Blue

HALO LED LIGHT

Property	Value
Input	350mA
Power	1W
Mode	Constant Current
IP Level	IP65
LED	CREE
Material	Aluminum
Hole diametre	27mm

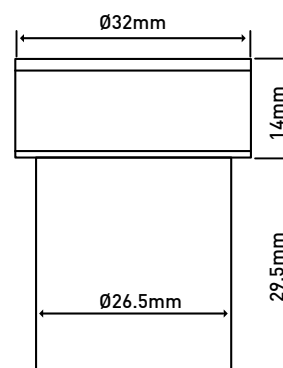
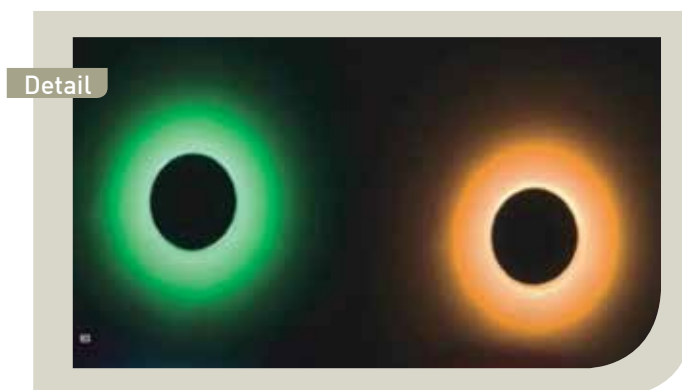

References:

Model	Description	GTIN/ EAN	Price*
YCH01WDCA36030	Warm White	5420061207845	€ 34.00
YCH01WDCA36060	Cool White	5420061207852	€ 34.00

*BRUTO WITHOUT VAT/PIECE

Other colors available on request : Amber, Red, Green, Blue

TECHNICAL INFORMATION

IP RATING (INGRESS PROTECTION)



1st Number: Protection against solid bodies		2nd Number: Protection against liquids	
IP0X	Non protected	IPX0	Non protected
IP1X	Protected against solid objects 50mm Ø or more	IPX1	Protected against vertically falling water drops (from condensation)
IP2X	Protected against solid objects 12,5mm Ø or more	IPX2	Protected against vertically falling water drops when enclosure tilted up to 15
IP3X	Protected against solid objects 2,5mm Ø or more (tools, screws, ...)	IPX3	Protected against spraying water up to 60 from vertical
IP4X	Protected against solid objects 1mm Ø or more (needle, wire, ...)	IPX4	Protected against splashing water from any direction
IP5X	Dust protected (no damage by deposit)	IPX5	Protected against jets of water from any direction
IP6X	Dust tight	IPX6	Protected against powerfull jets of water from any direction
		IPX7	Protected against immersion
		IPX8	Protected against continous immersion in specified conditions

SAFETY CLASS

ELECTRICAL SHOCK PROTECTION



Each luminaire is insulated so that any exposed metal parts do not carry electrical current. Parts that carry current during normal operation must be protected against contact either by insulation or a suitable cover.

Additional measures are taken to prevent exposed metal parts carrying current even if an insulation fault occurs

	Class I	Basic insulation plus protective earth connector
	Class II	Double or reinforced insulation, no provision for protective earthing
	Class III	Class III Supply of safety extra-low voltage (50V max.)

IGNITION / FIRE PROTECTION !

When operated, luminaires generate heat. The following symbols are used for luminaires that can be mounted on flammable materials.

	Luminaires are suitable for direct mounting on normally flammable materials, in which you may not exceed 130°C (in normal operation) and 180°C (in fault case) for less than 15 min.
	Luminaires are suitable for direct mounting on materials that have normal or reduced flammability, in which you may not exceed 95°C (in normal operation), 130°C (in abnormal operation) and 180°C (in fault case) for less than 15 min. Maximum temperature on the mounting surface: 130°C.
	Luminaires are suitable for direct mounting on materials for which the flammability properties are not known, in which you may not exceed 95°C (in normal operation), 115°C (in abnormal operation fault case).

DIRECTIVES



RoHS DIRECTIVE

The RoHS Directive came into force on 1st July 2006 and stands for 'Restriction of the use of Hazardous Substances in electrical and electronic equipment'. This means electrical and electronic equipment containing more than the agreed level of lead, cadmium, mercury, hexavalent chromium, polybrominated biphenyl (PBB) and polybrominated diphenyl ether (PBDE) flame retardants are banned in the EU market. It is permissible to sell products produced before 1st July 2006 without showing compliance, but product manufactured after this date will need to meet the RoHS requirements.



WEEE DIRECTIVE

The WEEE Directive (Waste Electrical and Electronic Equipment) came into force in January 2007. It aims to reduce the amount of waste and get everyone to reuse and recycle. The Directive also aims to help businesses that manufacture improve their environmental performance supply, use, recycle and recover electrical and electronic equipment.

LIGHTING RECOMMENDATIONS

STANDARD VALUES FOR LIGHTING OF INDOOR AND OUTDOOR WORKPLACES

E_m gives the illuminance maintenance values specified in the European standards (Lighting of indoor workplaces, EN 12464-1, April 2003) which partially or completely replace national standards. Illuminance levels must not fall below the **E_m** maintenance values in the visual task area. If the precise location is not known, the limit should be applied to the whole room or a specific working area.

UGR_L is the upper limit for direct glare. The UGR value calculated in the design process must lie below this (the Quickplan tables give the UGR figure for the luminaire used in a medium-size reference room).

R_a is the lower limit for the colour rendition index. The Ra of the selected lamp must be equal to or greater than this value.

Type of interior, task or activity	E_m	UGR_L	R_a
Circulation areas and corridors	100	28	40
Stairs, escalators, travelators	150	25	40
Store and stockrooms	100	25	60
Filing, copying, etc	300	19	80
Writing, typing, reading, data processing	500	19	80
Technical drawing	750	16	80
CAD work stations	500	19	80
Conference and meeting rooms	500	19	80
Reception desk	300	22	80
Archives	200	25	80
Sales area	300	22	80
Till area	500	19	80
Entrance halls	100	22	80
Ticket offices	300	22	80
Restaurants and hotels: Reception/cashier desk, porters desk	300	22	80
Kitchen	500	22	80
Educational buildings, Classrooms, tutorial rooms	500	19	80

